



## **Scrubmaster B175 R (7180)**

### **Operating Manual**

Part number 88-10-3115 - 3922-xx

Valid as from: 04.2018

## Introduction

### Foreword

Dear Customer,

We are certain that the excellent qualities of the machine will justify the faith you have shown in us by your purchase.

To guarantee safe working with the machine, please read the Safety Notes chapter before putting it into service.

Your own safety, as well as the safety of others, depends essentially on your ability to control the vehicle. Please read this **original operating manual** before you use the vehicle for the first time, act accordingly and keep these instructions for future reference or subsequent users. The operating manual contains all important information for operation, maintenance and care. We have provided the places in this operating manual concerning your safety with a danger pictogram. Your authorised Hako dealer is available at all times to answer further questions about the vehicle or the operating manual.

We would expressly advise you that no legal claims may be asserted based on the contents of this operating manual. In the case of necessary repair work, please make sure that only original spare parts are used. Spare parts must be original spare parts to guarantee safety. We reserve the right to make changes in the interests of further technical development.

**Hako GmbH**  
**23843 Bad Oldesloe, Germany**  
**Hamburger Str. 209-239**  
**Phone +49 4531 806-0**

### Issue:

Index	Book number	Change no.	Valid as from:
0	88-10-3115	3922-00	04.2018

**Intended use**

Scrubmaster B175 R is a scrubber-drier for the wet cleaning of hard indoor floor surfaces. This machine is intended for commercial use, e.g. in shopping centres, swimming pools, shops, airports, schools and hotels. Any use extending beyond this is not intended use. The manufacturer is not liable for any damage resulting from this and the user alone bears the risk. Intended use also includes compliance with the operating, maintenance and servicing conditions specified by the manufacturer.

The Scrubmaster B175 R may be used, maintained and repaired only by persons who are familiar with this work and instructed about the dangers. The relevant accident prevention regulations as well as the other generally recognised safety engineering and occupational medical rules must be complied with.

The machine corresponds by virtue of its design and construction as well as in the version distributed by us to the usual health and safety requirements of the EC Directives (see Declaration of Conformity). This declaration loses its validity in the event of a modification to the machine not authorised by us. The manufacturer is not deemed liable for any damage resulting from unauthorised modifications to the machine.

**Notes on warranty**

The terms defined in the purchase agreement apply. Claims for compensation in relation to damage are excluded from the terms of the warranty when the damage is the result of the failure to observe rules concerning servicing and maintenance. Maintenance work must be carried out by an authorised Hako service workshop and confirmed in the "Maintenance Report", which serves as a warranty logbook.

The following are excluded from the terms of warranty: wear and tear through overuse, defective fuses, improper handling and use and unauthorised modifications. Claims under the terms of the warranty are also annulled when damage occurs to the machine resulting from the use of parts or accessories not explicitly approved of by us or from failure to observe maintenance rules.

**Acceptance of the machine**

Inspect the machine immediately on delivery for signs of transport damage. You will be compensated for transport damage provided you immediately have the damage confirmed by the transport company and send in the damage report together with the consignment note to us.

**Machine data**

Your machine is described clearly by the following data. Please always quote these data in correspondence or when making a telephone query to your authorised Hako dealer or our company.

- Machine type \_\_\_\_\_
- Manufacturing no. \_\_\_\_\_
- Start-up on: \_\_\_\_\_

**Your nearest authorised Hako dealer:**

- Address: \_\_\_\_\_  
\_\_\_\_\_  
\_\_\_\_\_
- Telephone: \_\_\_\_\_

<b>1</b>	<b>Safety instructions .....</b>	<b>8</b>
1.1	Warning and danger symbols .....	8
1.2	General safety instructions .....	9
1.3	Operating safety instructions .....	10
1.4	Maintenance instructions .....	11
1.5	Information about special risks .....	12
1.6	Environmental protection instructions and disposal .....	14
1.7	Labels on the machine .....	15
<b>2</b>	<b>Operation.....</b>	<b>18</b>
2.1	Overviews .....	18
2.1.1	Front view .....	19
2.1.2	Rear view .....	21
2.1.3	Control panel .....	22
2.2	Controls and display elements .....	24
2.2.1	Control panel .....	24
2.3	Multifunction display (MFD) .....	29
2.3.1	Menu guidance .....	29
2.3.2	Main menu .....	30
2.3.3	Sub-menu .....	36
2.3.4	Controls at the machine .....	40
2.4	Functional description: .....	42
2.4.1	Solution tank .....	42
2.4.2	Rotating brush and roller brush unit .....	43
2.4.3	Side brush unit .....	43
2.4.4	Wiper .....	43
2.4.5	Squeegee .....	44
2.4.6	Waste water tank .....	44
2.4.7	Suction turbine .....	44
2.4.8	Travel drive .....	45
2.4.9	Brakes .....	45
2.4.10	Batteries .....	45
<b>3</b>	<b>Operation.....</b>	<b>46</b>
3.1	Instruction .....	46
3.2	Before putting into service .....	46
3.3	Check list: Before machine start-up .....	47
3.3.1	Installing the mains cable .....	47
3.3.2	Driver's seat .....	48
3.4	Cleaning .....	50

3.4.1	Fleet-Recorder (option) .....	51
3.4.2	On-board dosing system (option) .....	52
3.4.3	Useful cleaning tips .....	53
3.4.4	Handling and braking the vehicle .....	54
3.4.5	Pushing the machine .....	55
3.4.6	Turning off the machine .....	56
3.4.7	Check list: After cleaning .....	56
3.5	Loading and transporting .....	57
3.6	Service information .....	58
<b>4</b>	<b>Technical data.....</b>	<b>61</b>
<b>5</b>	<b>Maintenance and Servicing .....</b>	<b>64</b>
5.1	Maintenance certificate .....	65
5.2	Maintenance plan .....	66
5.3	Battery .....	69
5.3.1	Checking the charging state .....	69
5.3.2	Charge the battery .....	70
5.3.3	Checking the acid level .....	74
5.3.4	Replacing the battery .....	75
5.3.5	Battery plug coding .....	76
5.3.6	Maintaining drive batteries .....	77
5.3.7	Taking the machine out of service for a long period .....	77
5.3.8	Disposing of batteries .....	77
5.4	Solution tank .....	78
5.4.1	Filling the solution tank .....	78
5.4.2	Emptying the solution tank .....	80
5.4.3	Cleaning the solution tank .....	80
5.5	Waste water tank .....	81
5.5.1	Emptying the waste water tank .....	81
5.5.2	Cleaning the waste water tank .....	82
5.5.3	Cleaning the coarse dirt sieve .....	83
5.5.4	Cleaning the intake sieve .....	83
5.5.5	Checking the seal at the drain valve .....	83
5.5.6	Cleaning the fresh water filter .....	84
5.5.7	Checking the seal in the tank cap .....	84
5.6	Rotating brush unit .....	85
5.6.1	Replacing the brushes/pads .....	85
5.6.2	Cleaning the brushes .....	85
5.6.3	Ejecting the brushes/pads .....	86
5.6.4	Coupling the brushes/pads .....	86
5.7	Roller brush unit .....	87

5.7.1	Emptying the dirt hopper .....	87
5.7.2	Replacing the brushes .....	88
5.7.3	Cleaning the brushes .....	88
5.7.4	Disassembling the brushes .....	88
5.7.5	Installing the brushes .....	88
5.8	Side brush unit (optional) .....	89
5.8.1	Adjusting the side brush .....	89
5.8.2	Changing the side brush .....	90
5.9	Squeegee .....	91
5.9.1	Cleaning the squeegee .....	91
5.9.2	Changing the sealing / slot strip .....	93
5.9.3	Adjusting the sealing strips .....	94
5.10	Wiper .....	96
5.10.1	Changing the wiper rubber .....	96
<b>6</b>	<b>Attachments/options .....</b>	<b>97</b>
6.1	Spray suction tool .....	97
6.2	Manual suction tool: .....	98
6.3	Spray nozzle .....	99
	<b>EC Declaration of Conformity .....</b>	<b>101</b>

# 1 Safety instructions

## 1.1 Warning and danger symbols

Important tasks concerning the safety of the operator and machine are named as follows in this operating manual and emphasised by symbols.



### **Danger**

Indication of a direct danger with high risk, in which death or severe physical injury can occur if it is not avoided.



### **Warning**

Indication of a possible danger with average risk, in which death or severe physical injury can occur if it is not avoided.



### **Caution**

Indication of a danger with low risk, in which light to medium severe physical injury or material damage can occur if it is not avoided.



### **Attention**

Attention indicates a hazard that can lead to technical damage when not observed.



### **Environmental danger**

Environmental danger due to the use of substances from which a health and environmental risk proceeds.



### **Note**

Indication of information that facilitates more effective and economical use of the machine.



**Note**

Before starting up the machine, read the following safety instructions and act accordingly. Machine operating errors can be avoided and trouble-free operation can be guaranteed only with precise factual knowledge.

## 1.2 General safety instructions

- Apart from the instructions in this operating manual, the general safety and accident prevention regulations of the legislation must be taken into account.
- Before the machine is put into service, please carefully read the operating manual you receive as well as further separate instructions for additional implements or attachments and observe them in all aspects of your work.
- The machine may be used, maintained and repaired only by persons who have been instructed by Hako experts.
- The machine is not intended for use by persons (including children) with reduced physical, sensory or mental capabilities or by persons lacking the required experience and knowledge.
- Children should be supervised to ensure they do not play with the machine.
- The operating manual should always be available at the machine's place of use and should therefore be stored with the machine.
- Please hand over these documents to the new owner/operator on sale or rental of the device. Have the hand-over confirmed!
- The labels attached to the machine provide important information for safe operation. Renew labels that are no longer legible or present.
- Only wheels (wheel tyres) approved by Hako may be used.
- With Hako-AntiBac® machine variants, the plastic inner surface of the fresh water and waste water tanks contains silver ions in nanoparticle form.
- Spare parts must be original spare parts to guarantee safety.

## **1.3 Operating safety instructions**

### **Before putting into service**

- Before initially starting up the machine, charge the used battery fully and appropriately with commissioning charge. Please observe the operating manual of the charger and the operating manual of the battery manufacturer. Hako assumes no liability for battery damage resulting from insufficient commissioning charge.
- Check the machine for operating safety before every start-up! Eliminate faults immediately.
- Before starting work, the operator must familiarize himself with all equipment, operating and actuating elements as well as with their function. It is too late to do this during operation!

### **During operation**

- Sturdy and slip-proof shoes must be worn when working with the machine.
- Only those surfaces approved by the contractor or its authorised representative for use of the machine may be driven on.
- If the machine is used in areas in which objects may fall down, this is only permitted if it has a roof which protects the driver.
- When working with the machine, pay special attention to third persons, especially children.
- When driving over thresholds, raise the brush head.
- Only use detergents suitable for automatic machines (foam retarded) and observe the application, disposal and warning instructions provided by the detergent manufacturer.
- The machine is not suitable for removing liquids, dusts or materials that are dangerous to health, combustible or explosive. It is also prohibited to collect burning objects, e.g. glowing cigarettes. The collection of wood dust, e.g. beech and oak dust, is also prohibited – health hazard!
- Excessive quantities of dust must be avoided when working with the side brush unit!
- The machine is not suitable for collecting large quantities of water, e.g. in the event of flooding.
- For reasons of safety, the driver's seat is equipped with a seat contact switch. The machine can only be started when the driver is sitting on the driver's seat. The function of the seat contact switch must not be bypassed.
- The machine must not be used in potentially explosive atmospheres.
- It is not permitted to transport other people or heavy objects.
- When transporting the machine, raise the squeegee and the brush head. Adjust your way of driving to local conditions.

- Drive slowly on wet surfaces, particularly in bends, due to the risk of skidding.
- Drive slowly into the bend when driving downhill.
- For cleaning, the machine must only be used on a level surface with a maximum slope of 6 %.
- Transport journeys on slopes of up to 10 % must only take place for a limited period of time and with special caution.
- Manipulating the switches and protective devices is forbidden.

### **After operation**

- Remove the key when leaving the machine to prevent unauthorised use.
- After use, park the machine in a dry, indoor location with the brush head and squeegee raised.

### **1.4 Maintenance instructions**

- Daily and weekly maintenance work must be done in accordance with the maintenance plan by the operating staff. In all other maintenance work, please contact your nearest Hako service centre.
- The maintenance work and maintenance intervals specified in the operating manual must be complied with.
- Suitable tools and protective clothing such as gloves and safety goggles must be used during cleaning and maintenance work.
- Have the machine checked for safe condition by an expert in accordance with the accident prevention regulations at appropriate intervals (we recommend at least once yearly).
- Spare parts must at least comply with the technical requirements specified by the manufacturer. This is guaranteed by original spare parts.
- Turn the machine off and disconnect the battery connector when cleaning and maintaining the machine and before replacing parts.
- To prevent unauthorised use of the machine, remove the ignition key.
- Cleaning the machine with a high-pressure cleaner or steam jet is not allowed.
- Application of aggressive and corrosive detergents is not allowed.
- After cleaning, let the machine air dry, e.g. over the weekend.
- Only put the machine into service when all the protective devices are attached and in protection position.

## **1.5 Information about special risks**

### **Electrical system**

- If the electrical system is faulty, always turn off the machine, disconnect the battery and eliminate the fault.
- Work on the electrical system may be done only in accordance with electrical engineering standards by a specialist trained for this work.
- Regularly inspect/check the electrical system of the machine. Defects such as loose connections, loose nuts of electrified bolts, electrical components or damaged cables must be eliminated immediately.
- Only use original fuses with the specified current. If stronger fuses are used, the electrical system can be destroyed and fires may occur.

### **Batteries**

- Observe the operating manuals and safety instructions provided by the battery manufacturer.
- Never connect or disconnect batteries when the machine is turned on.
- Make sure the batteries are never fully discharged; recharge them as quickly as possible.
- Only instructed maintenance personnel must handle and replace batteries.
- Only batteries approved by Hako may be used at the intended position.
- **Danger!** Make sure that the insulation of the battery cables is not damaged. The battery cables should not rub against anything. If the insulation is defective, no longer use the machine and have the battery cables replaced by the Hako customer service immediately.
- **Caution!** Always make sure that the batteries are clean and dry to avoid creeping currents and corrosion damage. Protect the batteries, in particular, against conductive contamination, e.g. metal dust.
- **Risk of short circuits and spark formation!** Never place tools or other electrically conductive objects on the battery!
- Do not remove insulating caps and covers, if necessary re-install them after carrying out work on the battery cables.
- **Caution!** Explosive gases can develop when charging the batteries. Avoid smoking, fire or naked light in the vicinity of batteries. Ensure sufficient ventilation when charging the batteries.
- For further safety instructions, see Hako supplementary sheet 88-60-2556 – information for drive batteries.



### **Power connection and mains plug**

- Only connect the machine to an electrical connection installed by an electrician in accordance with IEC 60364-1.
- We recommend connection to a fused socket with a residual current circuit breaker (max. 30 mA).

- We recommend use of splash water protected sockets according to DIN VDE 0620-1.
- Make sure the socket is dry!
- Only touch the mains plug and the mains cable with dry hands.
- Never insert the mains plug into the socket when the floor is wet or damp.
- Never dip the mains cable or mains plug in water or other liquids or clean it under running water.
- Damp mains plugs or mains plugs that have become wet must no longer be used. Water can enter the mains plug. Only qualified electricians must carry out recommissioning.
- Check the mains cable regularly for damage. If damage is detected, the machine must no longer be used. Have a qualified electrician replace the mains cable.
- Make sure that no water or liquid can come into contact with live parts of the machine. If water has still entered parts, immediately disconnect the mains plug and have the machine checked by the authorised Hako service.

## 1.6 Environmental protection instructions and disposal

If the end of use of the machine or of its components is reached and this is handed over for scrapping, the components must be correctly disposed of. Further information about disposal is available through the competent local authorities and the authorised Hako dealers.

	Do not dispose of products with this symbol in domestic waste. Disposal takes place through local collecting points or the manufacturer.
	Recycle used materials with this symbol according to their labeling and do not dispose of them in domestic waste.

- Observe the applicable laws and local regulations when disposing of dirt, waste water and detergents, also see the German Water Resources Law (WHG).
- Used batteries with the recycling symbol contain reusable commodities. In accordance with the symbol showing the crossed-out garbage bin, these batteries must not be disposed of in the domestic waste. Return and recycling have to be arranged with the authorised Hako dealer as required in § 6 and § 8 of the German battery law (BattG)!

## 1.7 Labels on the machine

The following safety and instruction labels are affixed to the machine in a clearly visible and legible manner.



### Attention

Renew missing or illegible labels immediately!

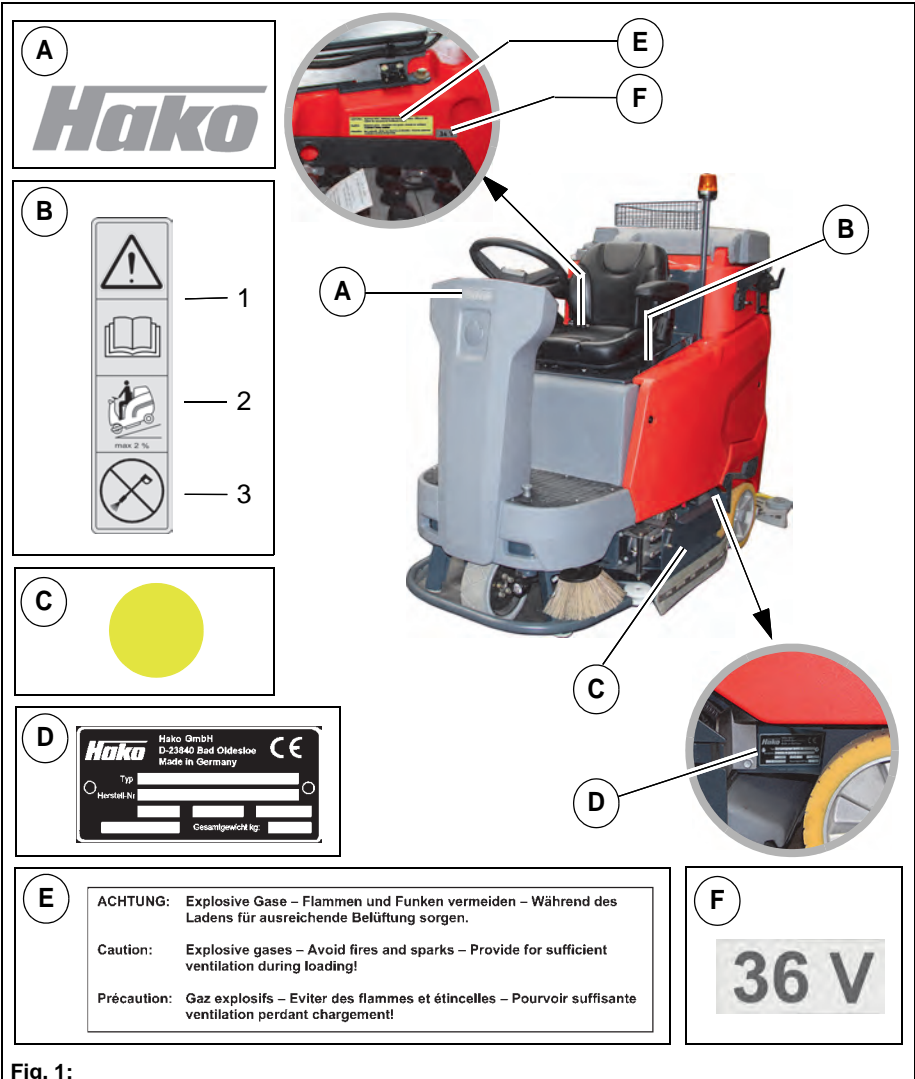

Fig. 1:

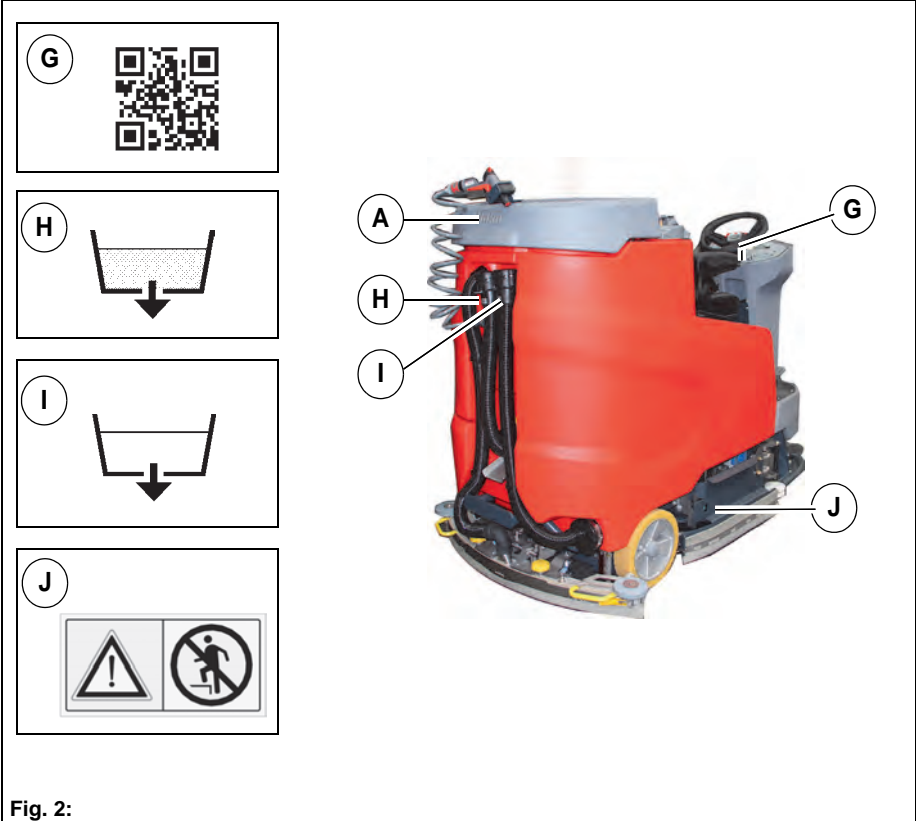

Fig. 2:



**Company logo label Fig. 1/ Fig. 2-A**

The Hako logo is located at the front on the steering column and at the rear on the hopper.

**Label**

- **Read and observe the operating manual Fig. 1-B1**
- **Maximum permissible slope 6 % when cleaning Fig. 1-B2**
- **Never clean the machine with a high-pressure cleaner Fig. 1-B3**

The label is located on the left hand side next to the driver's seat.

**Label – Maintenance parts (yellow dot) Fig. 2-C**

The yellow dot is located on the cover of the fresh water filter.

**Label – Type plate Fig. 2-D**

The type plate is located in front of the left front wheel.

**Label – Explosive gases Fig. 1-E**

The label is in the battery compartment.

**Label – 36 V Fig. 1-F**

The label is in the battery compartment.

**Label – QR code Fig. 2-G**

The label is located on the control panel.

**Label – Drain waste water Fig. 2-H**

The label is located on the drain hose of the waste water tank.

**Label – Drain fresh water Fig. 2-I**

The label is located on the drain hose of the solution tank.

**Label – Keep off! Fig. 2-J**

The label is located on the rotating brush or roller brush unit.

## 2 Operation

### 2.1 Overviews

The description in chapter 2 contains information on the function and handling of the individual controls on the machine. The controls always have the same item number in all chapters.

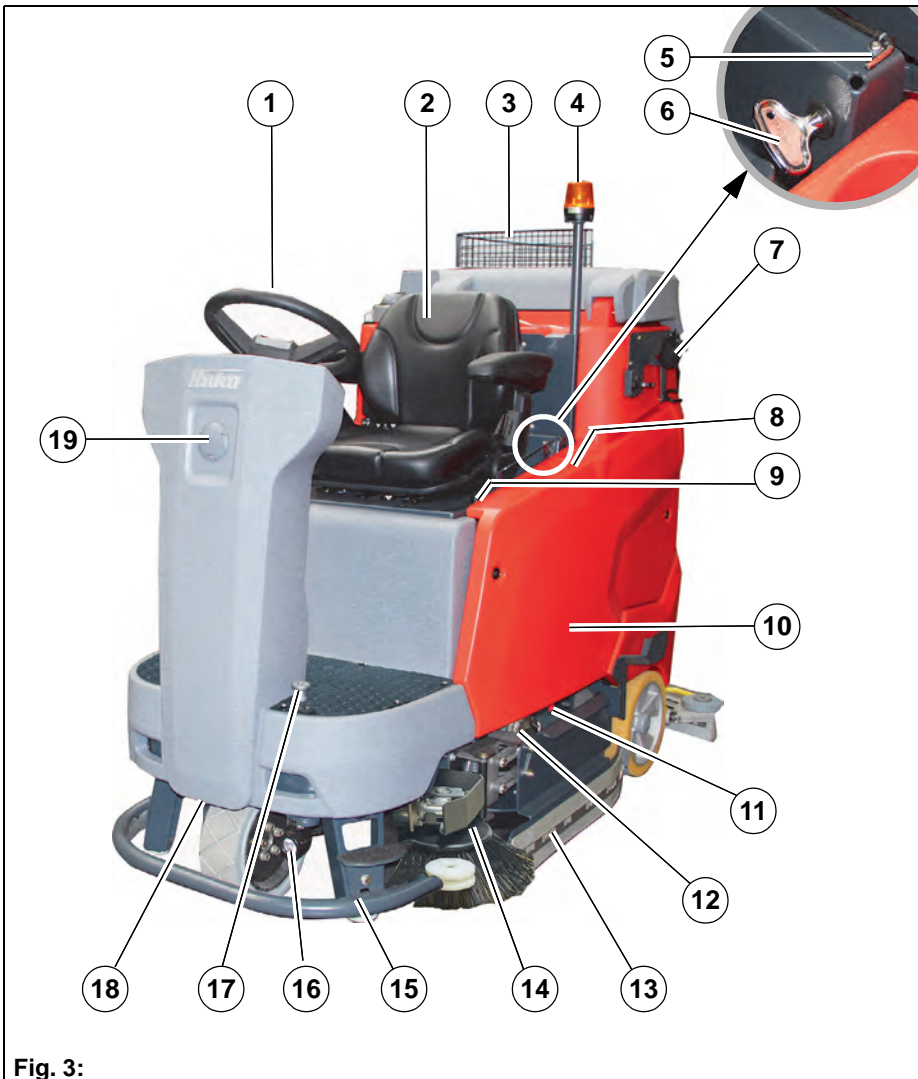

### 2.1.1 Front view

Item	Designation
1	Steering wheel
2	Driver's seat
3	Tray
4	Flashlight on a pole
5	Key for electronic system cover
6	Key for side panelling
7	Holder for manual suction tool or manual spray suction tool
8	Drinks holder and storage compartment
9	Socket for USB connection
10	Side panelling
11	Ball cock
12	Fresh water filter
13	Wiper
14	Side brush unit
15	Collision protection
16	Working light
17	Operating brake
18	Travel drive
19	Warning device

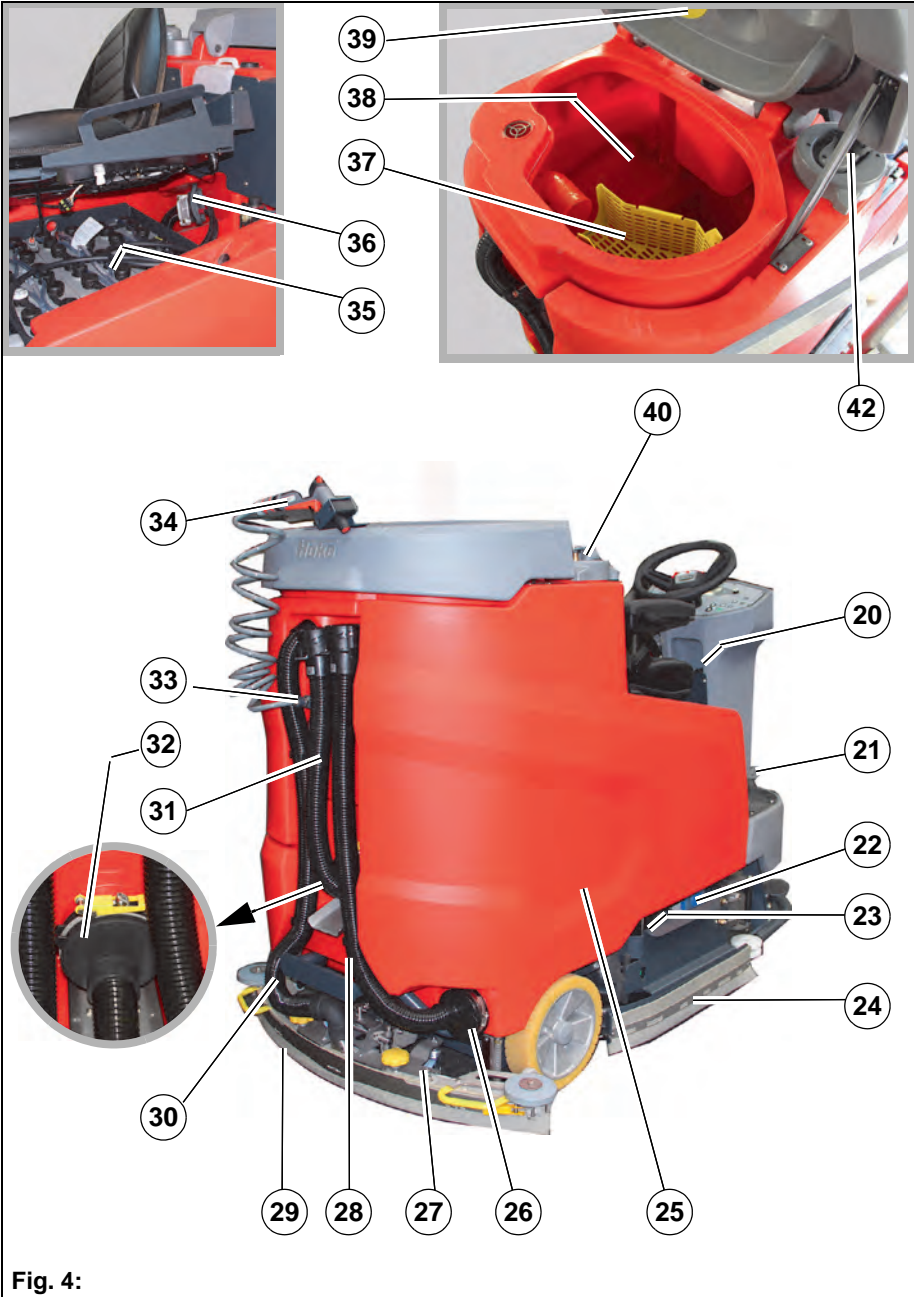

Fig. 4:

### 2.1.2 Rear view

Item	Designation
20	Mains cable
21	Accelerator pedal
22	On-board dosing system
23	Brush unit
24	Wiper
25	Solution tank
26	Maintenance opening solution tank
27	Squeegee water connection
28	Fresh water drain hose
29	Squeegee
30	Suction hose
31	Drain hose waste water
32	Waste water tank maintenance opening
33	Water connection
34	Spray nozzle
35	Battery compartment
36	Battery connector
37	Coarse dirt sieve
38	Waste water tank
39	Intake sieve
40	Filling opening
41	Automatic filling unit

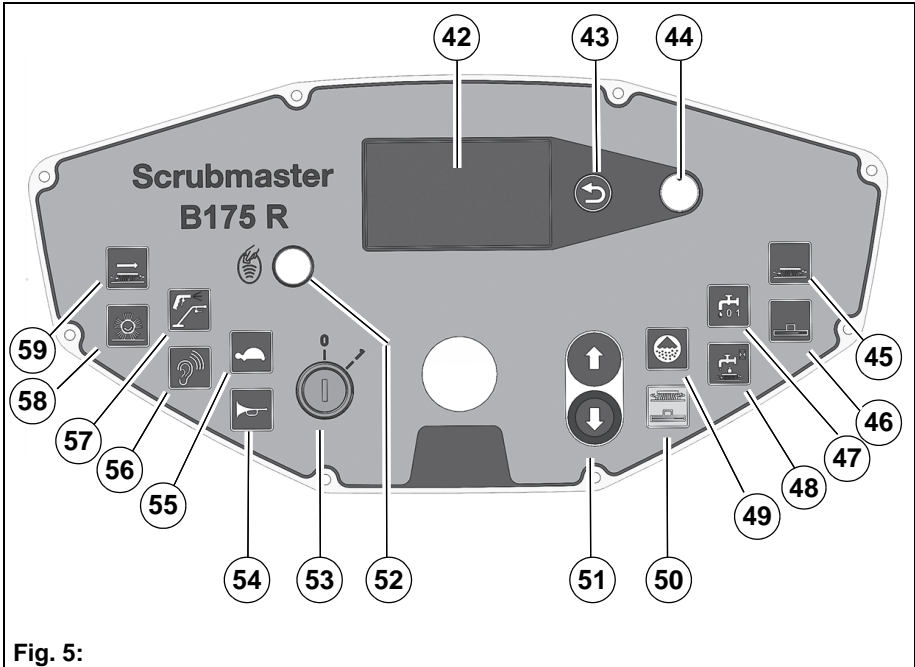

Fig. 5:

### 2.1.3 Control panel

Item	Designation
42	Multifunction display (MFD)
43	Return button
44	Turn-push knob
45	Button – brush unit
46	Button – squeegee
47	Button – fresh water supply
48	Button – boost function
49	Button – on-board dosing system
50	Button – brush unit and squeegee
51	Button – driving direction selection

52	Button – I-Button Reader, Fleet-Recorder Standard
53	Key switch
54	Button – signal horn
55	Button – speed reduction forwards gear
56	Button – silent operation
57	Button – tool operation
58	Button – pre-sweep suction unit
59	Button – side brush unit

## 2.2 Controls and display elements

### 2.2.1 Control panel

The individual functions of the buttons on the control panel are described below. The respective activated functions are visible as corresponding symbols in the multifunction display (MFD).



#### Key switch Fig. 5-53

The electrical system is switched on and off with the key switch.

- Position 0: The electrical system is switched off. The key can be pulled out.
- Position 1: The electrical system is switched on.
  - The software version is displayed for approx. 1 second on the MFD, followed by the last service code for approx. 3 seconds if necessary. The operating hours meter is then displayed.

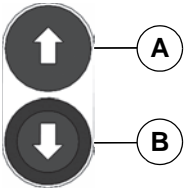

#### Driving direction selection button Fig. 5-51

The driving direction is selected with this button. The driving direction can be changed while driving.

- Push the button (A): Forwards gear
- Push the button (B): Reverse gear



#### Note

A warning signal is output when in reverse gear. The maximum speed when reversing is half of the maximum speed when driving forwards.





### Speed reduction button Fig. 5-55

The maximum speed when driving forwards is reduced by approx. 50 % with this button.

- Push the button: Speed reduction ON
- Push the button again: Speed reduction OFF



### Signal horn button Fig. 5-54

The signal horn is switched on and off with this button.

- Push the button: Signal horn ON
- Release the button: Signal horn OFF



### Fresh water supply button Fig. 5-47

The fresh water supply is switched on and off with this button.

- Push the button: Fresh water supply ON
- Push the button again: Fresh water supply OFF



### Boost function button Fig. 5-48

In order to remove heavy contamination, it is possible to boost the scrubbing-vacuuming cleaning program (green button **Fig. 5-50**) and scrubbing (button **Fig. 5-45**) using the boost function.

- Push and hold the button: The highest level of fresh water dosing and the increased brush pressure are activated simultaneously.
- Release the button: The machine switches back to the operating mode it was in before the boost function.



**Brush unit button Fig. 5-45**

The brush unit is lowered and raised with this button.

- Push the button: The brush unit is lowered. When actuating the accelerator pedal, the brush drive and the water supply are switched on.
- Push the button again: The brush drive and the water supply are switched off. The brush unit is raised.



**Note**

If the accelerator pedal is not actuated, the brush drive and the water supply are switched off.



**Squeegee button Fig. 5-46**

The squeegee is lowered/raised and the suction turbine switched on and off with this button.

- Push the button: The squeegee is lowered and the suction turbine switched on.
- Push the button again: The squeegee is raised. After an after-run time of approx. 15 seconds, the suction turbine is switched off.



**Note**

The squeegee is automatically raised when reversing. The suction turbine drive remains switched on.



### Button – on-board dosing system Fig. 5-49

The dosing system for the detergent is switched on and off with this button.

- Push the button: Dosing system ON
- Push the button again: Dosing system OFF



### Brush unit and squeegee button Fig. 5-50

The brush and suction turbine drive are switched on and off simultaneously with this button.

- Push the button: The brush unit, the side brush unit and the squeegee are lowered, and the suction turbine is switched on. The brush drive and the water supply are switched on when the accelerator pedal is actuated.
- Push the button again: The brush unit and the side brush unit are raised. The brush drive and the water supply are switched off. The squeegee continues to run for approx. 15 seconds to absorb residual water.



### Button – Side brush unit Fig. 5-59

The side brush unit is switched on and off with this button.

- Push the button: Side brush unit ON
- Push the button again: Side brush unit OFF



**Button – tool operation Fig. 5-57**

The following tools can be switched on and off using this button when the driver is not on the seat:

- Spray nozzle
- Manual suction or spray suction tool

If the machine does not have a particular tool, it is excluded from the switching order.

- Push the button: Spray nozzle ON
- Push the button twice: Manual suction and spray suction tool ON
- Push the button again: Tool operation OFF



**Button – silent operation Fig. 5-56**

The suction turbine is switched to silent operation with this button.

- Push the button: Silent operation ON
- Push the button again: Silent operation OFF



**I-Button Reader Fleet-Recorder Fig. 5-52**

The I-Button Reader is used to activate the functions.

Red illuminated LED or warning sound after switching on the machine request the activation of the operating data recording system via the I-Button Key.

- Push the I-Button-Key for approx. 2 seconds against the I-Button-Reader. The red LED goes out. The machine is ready for operation.

## 2.3 Multifunction display (MFD)

The functions and indicators of the machine are set and displayed with the multifunctional display. After the machine is switched on, the operating system and data are loaded and the start screen **Fig. 6-A** appears on the display. After several seconds the view changes, and the main menu **Fig. 6-B** appears. By selecting and confirming the soft key *Menu selection* **Fig. 6-C** you are taken to the sub-menu **Fig. 6-D**.



### Note

It is only possible to switch to the sub-menu if the cleaning functions are switched off!

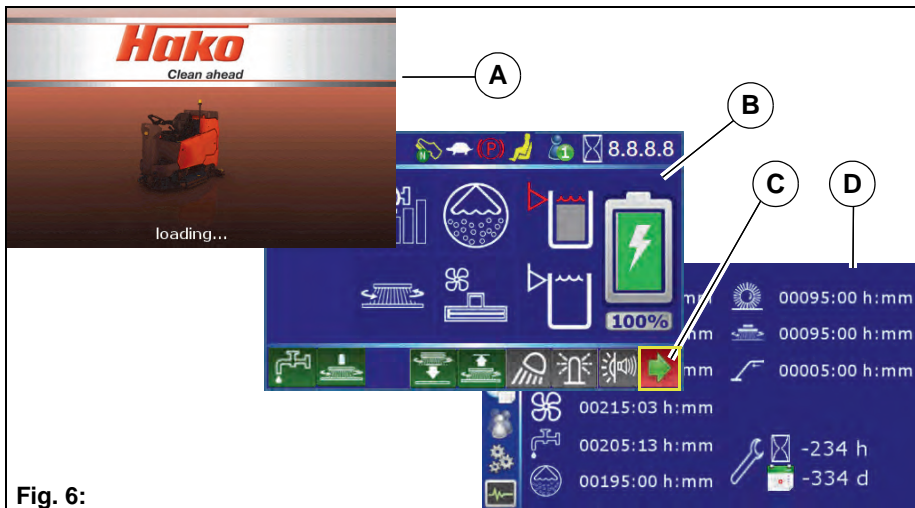

Fig. 6:

### 2.3.1 Menu guidance

The menu is operated with the turn-push knob **Fig. 5-44**

Menus and sub-menus are selected in the multifunctional display and the individual menu item values are set or changed with the turn-push knob. The following basically applies:

- Turn to select a menu item. The selected menu item is displayed with a yellow border.
- Push to activate a menu item.

You can jump back to the previous menu using the return button **Fig. 5-43**.

### 2.3.2 Main menu

The main menu is divided up into three levels.

- Status level **Fig. 7-A**
- Function level **Fig. 7-B**
- Action level **Fig. 7-C**

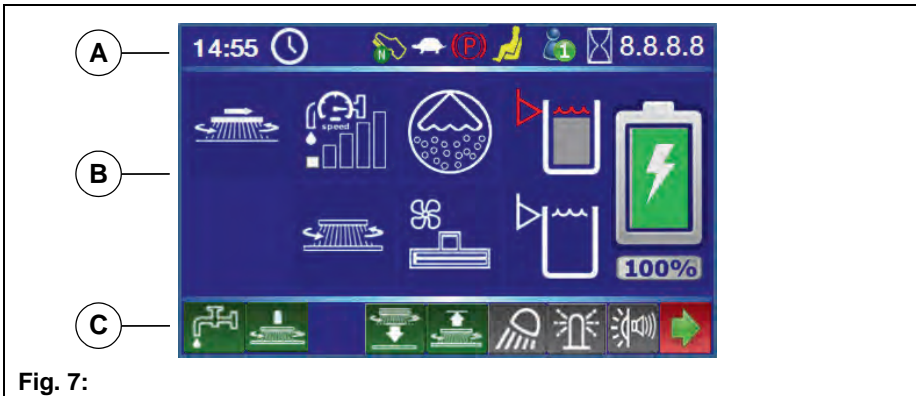













Fig. 7:









#### Symbols at status level

Symbol	Designation	Meaning
	Time	The current time is displayed in hours and minutes. Changes can be made to the time in the sub-menu.
	Service alarm clock	If the service alarm clock <i>Days</i> has elapsed, this symbol is permanently visible.
	Accelerator pedal in neutral position	This symbol appears when the accelerator pedal is in the neutral position.
	Speed reduction	The symbol is displayed when the machine is driving at reduced speed.
	Parking brake	The symbol is displayed when the parking brake is activated.

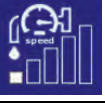

	Seat contact	The warning symbol lights up if the driver gets up from the driver's seat during operation. Main functions, e.g. scrubbing, vacuuming and driving, are no longer possible.
	User	The symbol indicates the current user setting.
	Silent operation	The symbol appears when the machine is working in reduced-noise operation. The symbol also appears at the <i>Squeegee</i> symbol.
	Operating hours meter	The operating hours in work mode are displayed. The operating hours for the individual units can be called up in the sub-menu.
	Service alarm clock	If the service alarm clock <i>Operating hours</i> has elapsed, this symbol is permanently visible.
	Service indicator	The symbol appears if a service case occurred, but it had already been eliminated automatically or by operator intervention.
	Service indicator	The symbol appears if a service case occurs. An acoustic warning is also output and a four-digit service code appears on the right next to the symbol, see section 3.6

**Symbols at function level**

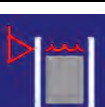
All active units are displayed as symbols at function level.





Symbol	Designation	Meaning
	Side brush unit	Side brush unit active
	Speed-independent water dosing	The selected water dosing is displayed in the bar diagram.
	Speed-dependent water dosing	The selected water dosing is displayed in the bar diagram. Water quantity adaptive to driving speed.
	On-board dosing system	On-board dosing system active
	Brush unit	Brush unit active
	Increased brush pressure	Brush unit operating with increased brush pressure
	Squeegee	Squeegee and suction turbines active
	Manual suction tool/spray suction tool	Manual suction tool or spray suction tool active
	Spray nozzle	Spray nozzle active
	Waste water tank full warning symbol	The symbol appears when the waste water tank is full. An acoustic warning is also output, and waste water collection is switched off. Empty the waste water tank immediately, see section 5.5.1.



Symbol	Designation	Meaning
	Solution tank full	The current filling level of the solution tank is shown descending in steps of 20 %.
	Warning symbol – solution tank empty	The symbol appears when the filling level of the solution tank is approximately 10 litres. A warning sound is additionally output. Fill the solution tank immediately, see section 5.4.1
	Battery charging state indicator	The current charge level of the battery is displayed in steps of 10 %, see section 5.3.1

### Additional symbols

For more information there are additional symbols, which are explained in the following.

Symbol	Designation	Meaning
	Warning symbol – red spanner	Faults in the functions are signalled by the red spanner. A 4-digit service code is also displayed at the same time.
	Warning symbol	If this symbol appears, the unit <ul style="list-style-type: none"> <li>• is not installed or</li> <li>• not configured</li> </ul> Example: On-board metering system not installed.
	Symbol <i>OFF</i>	If the symbol appears, the function is switched off. Example: the water supply is switched off.
	Function symbol displayed in yellow	Interrupted functions are shown in yellow, e.g. if the accelerator pedal is in the neutral position. Example: Function interrupted by brush unit.
	Symbol displayed in grey	If a symbol appears in grey, the function cannot be started because the prerequisites for starting have not been fulfilled. Example: Switch to sub-menu not possible.

**Action level**



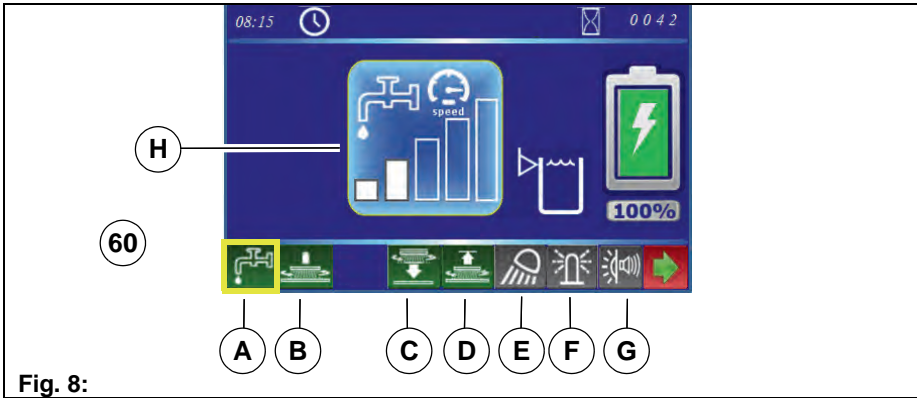

Settings can be made or actions performed in the action level using soft keys **Fig. 5-A to G**.





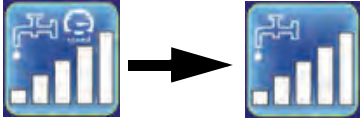

**Fig. 8:**

The soft keys are selected by rotating the turn-push knob (soft key with yellow border) and confirmed by pressing. An action window opens **Fig. 8-H**, in which the actions can be carried out using the turn-push knob.

The following actions are possible:

Soft key	Action window/ soft key	Setting
<b>A</b> Water dosing	 	Depending on the presetting, the action window appears for speed-dependent or speed-independent water dosing. <ul style="list-style-type: none"> <li>The water dosing has 5 settings:</li> <li>After reaching the highest speed-dependent water quantity, the speed dependence is deactivated by turning the turn-push knob clockwise.</li> </ul> 
<b>B</b> Brush pressure increase		Brush pressure increase ON/OFF Green background = active

<p><b>C</b> Decoupling the brushes</p>		<p>Ejecting the brushes, see section 5.6.3</p>
<p><b>D</b> Coupling the brushes</p>		<p>Coupling the brushes, see section 5.6.4</p>
<p><b>E</b> Working light</p>		<p>Working light ON/OFF by means of direct selection using the soft key. If the working light is switched on, the colour of the soft key changes from white to green.</p>
<p><b>F</b> Flashlight</p>		<p>Flashlight ON/OFF by means of direct selection using the soft key. If the flashlight is switched on, the colour of the soft key changes from white to green.</p>
<p><b>G</b> Forward travel warning device</p>		<p>The following settings can be selected in the action window:</p> <ul style="list-style-type: none"> <li>• Turn indicator ON/OFF</li> <li>• Acoustic warning ON/OFF</li> <li>• Turn indicator and acoustic warning ON/OFF</li> </ul> <p>If the respective function is switched on, the colour changes from white to green.</p>

### 2.3.3 Sub-menu

Configuration can be carried out, operating data read off and the clock/calendar set in the sub-menu. Some sub-menus require additional access rights. After calling up the sub-menu, the cursor automatically jumps to the operating hours menu.

To return to the main menu, press

- soft key *Home* **Fig. 9-A** or
- the return key on the control panel **Fig. 9-43**

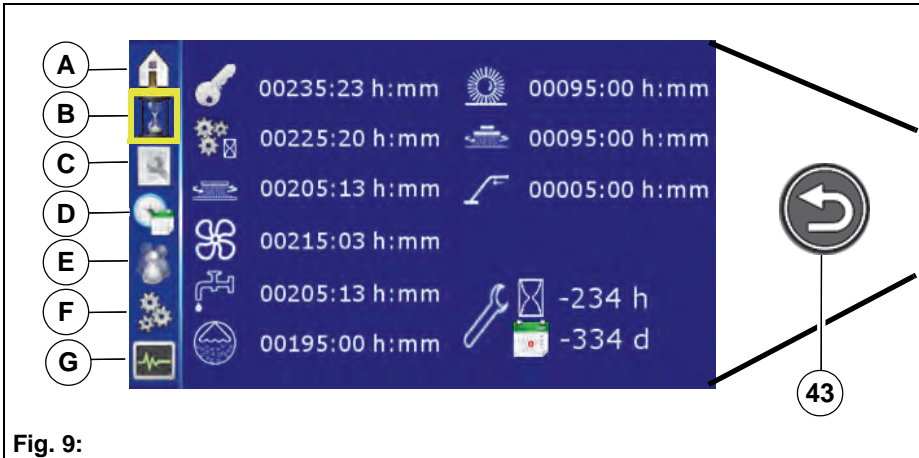

Fig. 9:

The following sub-menus can be selected:

Operating hours meter menu Fig. 9-B	
<p>The screenshot shows a dark blue interface with a vertical sidebar of icons on the left. The main area displays several rows of data:         <ul style="list-style-type: none"> <li>00235:23 h:mm (with a sun icon) and 00095:00 h:mm</li> <li>00225:20 h:mm (with a gear icon) and 00095:00 h:mm</li> <li>00205:13 h:mm (with a water tap icon) and 00005:00 h:mm</li> <li>00215:03 h:mm (with a fan icon)</li> <li>00205:13 h:mm (with a water tap icon) and -234 h</li> <li>00195:00 h:mm (with a globe icon) and -334 d</li> </ul> </p>	<ul style="list-style-type: none"> <li>• As well as the machine activation time and work mode, the operating hours of the individual units are displayed.</li> <li>• The remaining time until the next service is displayed in hours/days at the bottom right. If a service is required, the spanner appears in red.</li> </ul>
Maintenance menu Fig. 9-C	
<p>The screenshot shows a blue interface with a vertical sidebar of icons on the left. The main area contains three large buttons:         <ul style="list-style-type: none"> <li>A 'START' button with an open book icon.</li> <li>An 'OFF' button with a water tap icon.</li> <li>An 'OFF' button with a fan icon.</li> </ul> </p>	<p>The maintenance menu contains the following menu items:</p> <ul style="list-style-type: none"> <li>• The <i>Maintenance instructions</i> sub-menu</li> <li>• Activation/deactivation of speed-dependent water dosing</li> <li>• Activation/deactivation of automatic squeegee cleaning</li> </ul>
<p>The screenshot shows a blue interface with a vertical sidebar of icons on the left. The main area contains two buttons:         <ul style="list-style-type: none"> <li>A 'START' button with an open book icon.</li> <li>A 'Diskette' icon.</li> </ul> </p>	<p>The <i>Maintenance instructions</i> sub-menu opens, in which pictures for daily cleaning and maintenance are stored. When this menu is exited, a diskette appears. By selecting and confirming the <i>Diskette</i> symbol, you are confirming that you have carried out the maintenance.</p>
<p>The screenshot shows two buttons for speed-dependent water dosing:         <ul style="list-style-type: none"> <li>An 'ON' button with a water tap icon and a green circle.</li> <li>An 'OFF' button with a water tap icon and a red circle.</li> </ul> </p>	<p>Speed-dependent water dosing ON/OFF</p>
<p>The screenshot shows two buttons for automatic squeegee cleaning:         <ul style="list-style-type: none"> <li>An 'ON' button with a fan icon and a green circle.</li> <li>An 'OFF' button with a fan icon and a red circle.</li> </ul> </p>	<p>Automatic squeegee cleaning ON/OFF, see section 5.9.1</p>

**Time/date menu Fig. 9-D**



**Time:**

- Choice between 12 hour or 24 hour display
- Set the clock in hours and minutes

**Date:**  
Set the date: day, month and year.  
The set values are taken over when the menu is exited.

**User settings menu Fig. 9-E**



The *user settings* menu contains:

- Selection of:
  - Specified settings (1-6)
  - User-specific settings (A-C)
- Definition of:  
User-specific settings (A-C)



9 settings are available in the selection menu:

- The specified settings (1-6) contain predefined standard procedures
- User-specific settings (A-C) contain user-defined function procedures and function restrictions.

The selected, active user setting is displayed with a number/letter with a green background.



3 programs (A, B, C) with user-specific settings can be stored in this configuration menu.  
The modification of user profiles requires additional access rights.

**Configuration menu Fig. 9-F**



The following settings are made in the configuration menu:

- Activate/deactivate options
  - Setting of machine-specific parameters
- Making changes to the configuration menu requires additional access rights.

**Service information menu Fig. 9-F**



The last 10 items of service information are displayed in the service information menu.

The operator can perform the following actions:

- Delete the last service information when the fault has been remedied
- Obtaining detailed information



Deletion of the last service information from the display:

Select the *Delete* symbol with the turn-push knob and press the turn-push knob for 3 seconds.

The *Delete* symbol is now no longer visible and the service code is no longer displayed after starting up the machine.



If the *Information* symbol appears next to the service code, detailed information can be requested.

Select the *Information* symbol with the turn-push knob and confirm. Another window opens in which detailed information is displayed.

### 2.3.4 Controls at the machine

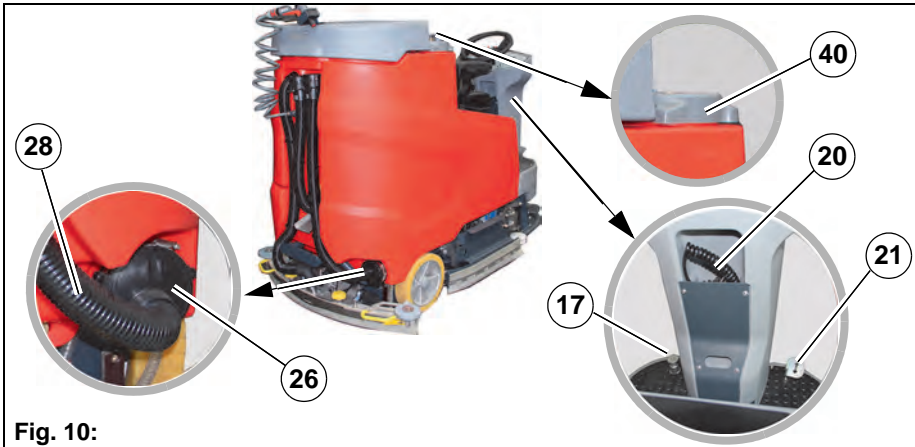

Fig. 10:

#### Mains cable Fig. 10-20

The mains connection supplies voltage to the on-board charger.

#### Operating brake Fig. 10-17

When the accelerator pedal is released, the machine comes to a stop due to the braking effect of the travel drive. If this braking effect is not sufficient, the operating brake can be applied in addition.

#### Accelerator pedal Fig. 10-21

The accelerator pedal is used to drive forwards or reverse and continuously adjust the speed at the same time.

If the accelerator pedal is not actuated, it automatically returns to the zero position and the machine stops.

#### Filling opening fresh water Fig. 10-40

The solution tank is filled via the filling opening. If the solution tank is filled using fast filling, the grey cover can be removed to increase the size of the filling opening.

Optionally, the solution tank can be filled via the automatic filling unit, see section 5.4.1.

#### Fresh water drain hose Fig. 10-28

The solution tank is drained using the drain hose.

#### Solution tank maintenance opening Fig. 10-26

The cleaning opening is used for cleaning the solution tank.



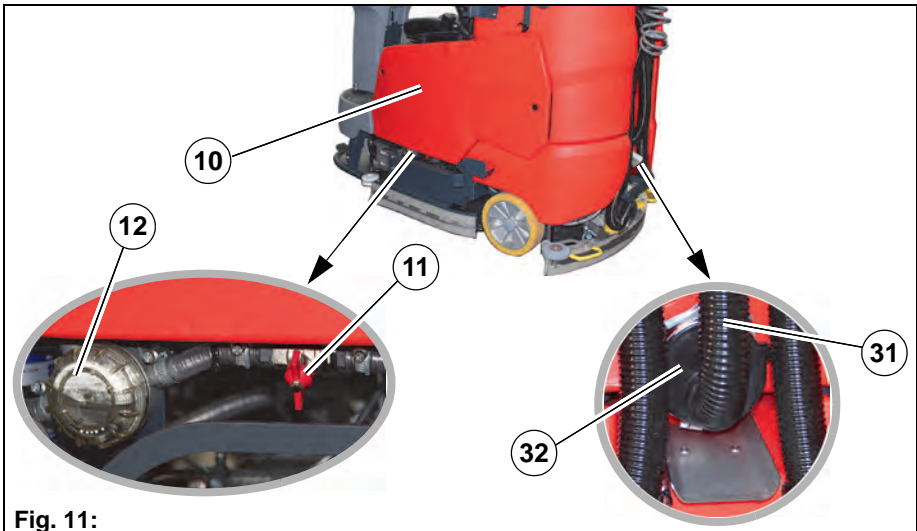

**Fig. 11:**

#### **Side panelling Fig. 11-10**

The trough batteries and the suction turbines are behind the side panelling. The side panelling can be easily removed using the provided wrench.

#### **Waste water tank maintenance opening Fig. 11-32**

The maintenance opening is used to drain the waste water and for cleaning the tank.

#### **Fresh water filter Fig. 11-12**

When supplying water from the solution tank to the brush unit, the fresh water is cleaned by the filter insert.

#### **Ball cock Fig. 11-11**

The ball cock is used to switch the water supply on and off manually in case the fresh water filter needs to be unscrewed.

#### **Drain hose for waste water Fig. 11-31**

The waste water that is collected is drained using the drain hose.

## 2.4 Functional description:

Scrubmaster B175 R is a ride-on scrubber-drier for wet cleaning hard floor surfaces. The Scrubmaster B175 R is intended for economical cleaning of large operational areas.

In cleaning mode, the cleaning solution is supplied from the solution tank to the rotating brushes in the brush unit. When the machine is moving forwards, the used waste water is absorbed by the squeegee and conveyed into the waste water tank.

A seat contact ensures that the machine can only be operated when the operator is sitting on the seat.

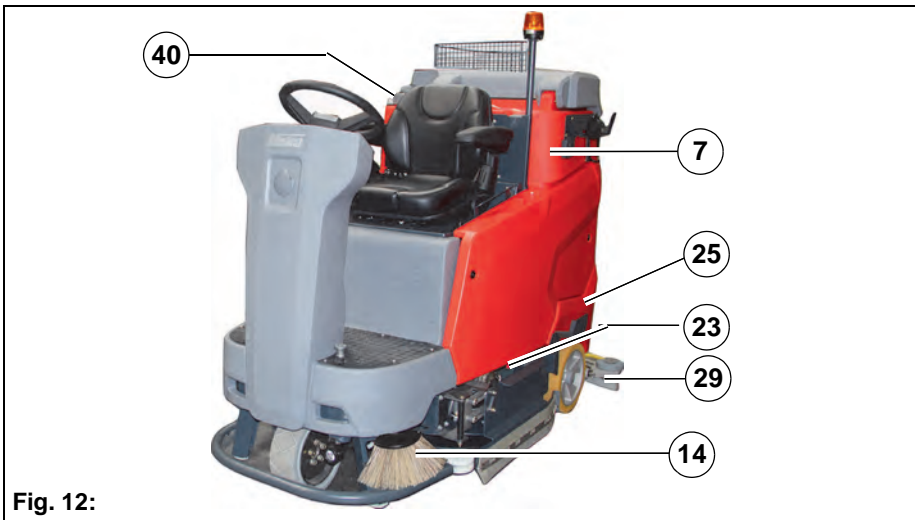

Fig. 12:

### 2.4.1 Solution tank

The solution tank **Fig. 12-25** is filled via the filling opening **Fig. 12-40**. The solution tank has a capacity of 175 litres. The current filling level is shown in the multifunctional display. If the filling level is less than 10 litres in the tank, the *Tank empty* symbol appears in the display and an acoustic warning indicates that topping up is required.

### 2.4.2 Rotating brush and roller brush unit

The brushes in the brush unit **Fig. 12-23** are driven by two electric motors. The brush unit is lowered using the *brush unit* **Fig. 5-45** button. When actuating the accelerator pedal, the brush motors and the water supply are switched on. The floor is cleaned by the rotating brushes and the supply of cleaning solution. The brush pressure can be changed in the MFD.

There is an indicator on the brush desk showing the amount of brush wear. The brushes in the rotating brush unit can be ejected for maintenance purposes by pressing the *Brush decoupler* **Fig. 8-C** soft key in the MFD, see section 5.6.3

### 2.4.3 Side brush unit

In order to brush up coarse dirt close to walls and beyond the squeegee, a side brush unit **Fig. 12-14** with two side brushes can be fitted at the front.

### 2.4.4 Wiper

To the right and left of the brush unit there are two wipers which avoid spray water at the side in the working position and lead the waste water to the centre of the vehicle, where it is easier to vacuum up.

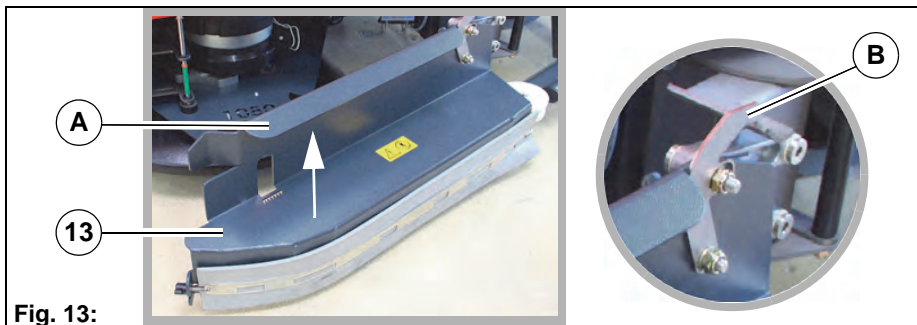

**Fig. 13:**

The wipers can be raised if necessary. To do this, raise the wiper at the handle **Fig. 13-A** and hook the locking hook **Fig. 13-B** into the bracket above it.

### 2.4.5 Squeegee

The movable, hinged squeegee **Fig. 12-29** is lowered and switched on with the *Squeegee* button **Fig. 5-46**. The squeegee withdraws the waste water from the floor using a sealing strip. The suction turbine vacuums the waste water from the floor. If the machine passes through narrow sections, e.g. checkout areas, the squeegee can be removed by loosening the star-shaped handle and hooked into the cover **Fig. 14-A** of the waste water tank. The squeegee can be swivelled up for maintenance purposes **Fig. 14-B**.

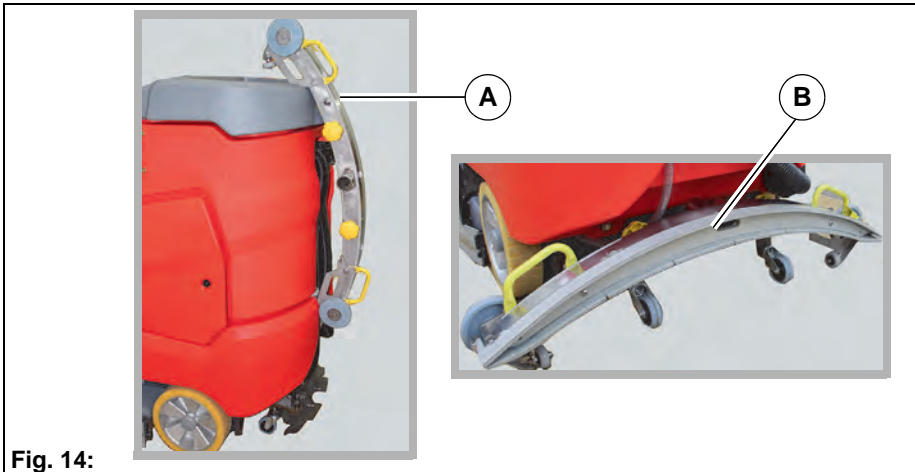

Fig. 14:

### 2.4.6 Waste water tank

The waste water vacuumed by the squeegee is conveyed via a suction hose **Fig. 14-30** from the squeegee into the waste water tank **Fig. 14-38**. A float switch inside the waste water tank automatically switches the suction turbine off when the maximum filling level is reached. In this case, a warning symbol illuminates in the MFD. An acoustic warning is output at the same time.

### 2.4.7 Suction turbine

The suction turbines are on the left-hand side of the machine and are accessible after removing the side panelling. The suction turbines are switched on and off automatically when the squeegee is lowered and raised.

### 2.4.8 Travel drive

The travel drive consists of an electric machine and a gearbox, and fulfils the functions of driving, braking and steering. Driving and braking are carried out using the electric machine. Steering is carried out using a connected steering rod. The gearbox does not require an oil change.

### 2.4.9 Brakes

The operator slows down the machine by releasing the accelerator pedal. A greater braking effect is achieved by operating the brake. When the machine comes to a standstill, the parking brake is automatically applied.

### 2.4.10 Batteries

The machine variants are equipped with different maintenance-free battery types.

- Trough battery 36 V/320 Ah PzS, wet
- Trough battery 36 V/280 Ah PzV, maintenance-free

#### **Battery management system (BMS)**

The Scrubmaster B175 R is fitted with a BMS. The BMS ensures that the battery system is monitored and secure. The BMS is responsible for:

- determining the battery charging state during operation
- switching off the cleaning functions when the discharge limit has been reached to protect the battery against total discharge



#### **Attention**

When using other batteries which have been approved by Hako, the BMS must be reset to protect the battery against total discharge. The settings of the BMS should only be carried out by a workshop authorised by Hako!

For more information, see section 5.3.1

## 3 Operation

### 3.1 Instruction

Instruction is required before the first start-up. The first-time instruction of the machine must be provided only by a specialist of your authorised Hako dealer. This person will be notified immediately after delivery of the machine from the factory and will contact you to make an instruction appointment.

### 3.2 Before putting into service



#### Attention

- Before initially starting up the machine, charge the used batteries fully and appropriately with commissioning charge. Please observe the instruction manual of the charging device and the instruction manual of the battery manufacturer. Hako assumes no liability for battery damage resulting from insufficient commissioning charge.
- Before the machine is initially put into service, install the country-specific Hako mains cable.
- Check the machine for operating safety before every start-up! Eliminate faults immediately.
- Before starting work, the operator must familiarize himself with all equipment, operating and actuating elements as well as with their function.

### 3.3 Check list: Before machine start-up

No.	Description
1	Checking the parking area for signs of leaks. Cables and tanks must not show any sign of leaks or damage.
2	Installing the mains cable, see section 3.3.1
3	Mounting the brushes and squeegee, see chapter Maintenance
4	Adjusting the driver's seat, if necessary, see section 3.3.2
5	Checking the battery charge and recharge it as required, see section 5.3.2
6	Emptying the waste water tank and clean it as required, see section 5.5
7	Filling the solution tank (see chapter Maintenance) and add detergent according to the manufacturer's specifications

#### 3.3.1 Installing the mains cable

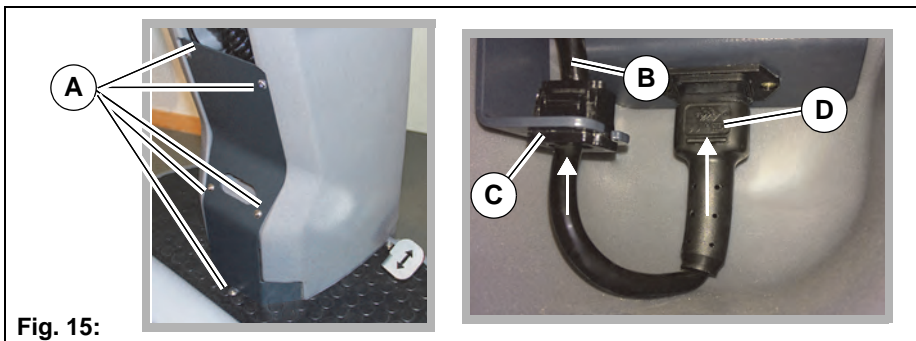

**Fig. 15:**

1. Loosen the bolts of the cover **Fig. 15-A** using the supplied socket wrench and remove the cover.
2. Route the cable of the mains plug **Fig. 15-B** through the opening in the bracket **Fig. 15-C**. Ensure that the side of the strain relief without a latch is facing the opening.
3. Push strain relief into bracket from below until all latches have engaged.
4. Plug the mains plug **Fig. 15-D** straight and firmly into the holder.
5. Reinstall the cover using the available screws.

### 3.3.2 Driver's seat



#### Attention

For reasons of safety, the driver's seat is equipped with a seat contact switch. The function of the seat contact switch must not be bypassed.

#### Danger

Do not adjust the driver's seat while driving. Risk of accident!

- Only adjust the seat if the machine is stationary.
- The driver's seat must audibly engage after adjustment.

Adjust the driver's seat in such a way that all controls can be easily reached.

#### Adjusting the standard driver's seat



Fig. 16:

Sit on the driver's seat and adjust as follows:

#### Adjust in longitudinal direction

- Push lever **Fig. 16-A** outwards.
- Move seat forwards or backwards.
- Release lever **Fig. 16-A** and let the driver's seat engage.



## Adjusting the driver's seat comfort

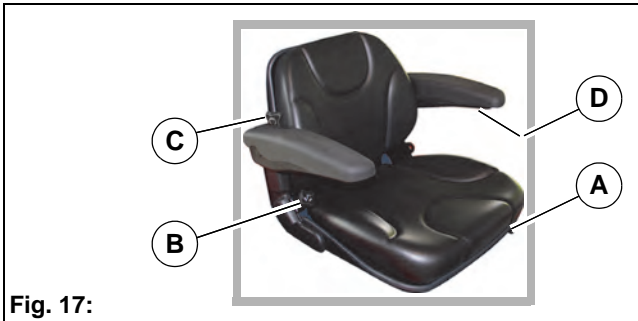

**Fig. 17:**

Sit on the driver's seat and adjust as follows:

### Adjust in longitudinal direction

- Push lever **Fig. 17-A** outwards.
- Move seat forwards or backwards.
- Release lever **Fig. 17-A** and let the driver's seat engage.

### Adjusting the tilt of the backrest

Adjust the tilt of the backrest by turning the handwheel **Fig. 17-B**.

### Adjusting the tilt of the armrests

Adjust the tilt of the armrests by turning the wheel **Fig. 17-D**.

The armrests can be folded up when not in use.









### Adjusting the seat suspension

The seat suspension can be continuously adjusted to the weight of the driver (50–120 kg) by turning the handwheel **Fig. 17-C**.

- Drivers who weigh less turn the handwheel **Fig. 17-C** to the left.
- Drivers who weigh more turn the handwheel to the right.

### 3.4 Cleaning

	<p><b>Attention</b></p> <ul style="list-style-type: none"> <li>• Before operating the machine, read and observe the safety instructions in chapter 1.</li> <li>• The machine can only be put into service when the driver is sitting on the driver's seat.</li> <li>• The travel drive can only be started if the accelerator pedal is not being actuated when the machine is turned on.</li> </ul>
---	---

No.		Description
1		Turn on the machine.
2		Activate the Fleet-Recorder (option)
3		Use the driving direction selection button to select the driving direction
4		Select the cleaning programme
5		Actuate the accelerator pedal. The brush unit and the water supply are switched on with the last selected setting.
6		If necessary, switch on the fresh water supply.
7		Set the fresh water quantity in the MFD using soft key <i>Fresh water dosing</i> .
8	 	In the event of heavy soiling, increase the brush pressure using soft key <i>Brush pressure</i> in the MFD or press the Boost button for 1 minute.

### 3.4.1 Fleet-Recorder (option)

The Fleet-Recorder records operating times and further operating conditions of the machine.

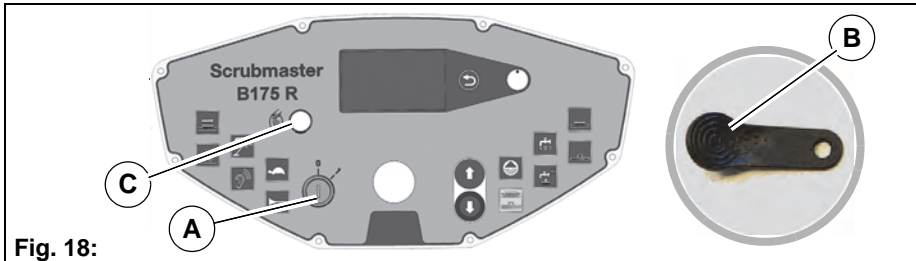

Fig. 18:

#### Putting into service

- Turn the machine on with the key switch **Fig. 18-A**.
  - Red LED of the I-Button Reader ON.
- Press the I-Button Key **Fig. 18-A** against the I-Button Reader **Fig. 18-B** for one to two seconds.
  - Red LED OFF.
  - Operating data recording system active.

If the machine is **not** registered with the I-Button Key, the following condition arises according to the selected option:

Option	Display LED	Machine function*	Data recording
50EC001	Red LED ON	Fully functional	The operating data recording is activated or fully suppressed according to the presetting. GPS data is recorded as standard.
50EC002	Red LED ON	Function of the working tools locked, transport possible	
50EC003	Red LED ON, a warning sound is additionally output after approx. 5 sec.	Fully functional	

\*deviating machine functions depending on the respective customer configuration possible



#### Note

A red illuminated LED or acoustic warning is a request for activation of the operating data recording system via the I-Button Key!

#### Ending operation

Switch off the machine using the key switch.

### 3.4.2 On-board dosing system (option)

The on-board dosing system is used for optimum dosing of the detergent.



**Attention**

Only use detergents suitable for automatic machines (foam retarded). We recommend use of our detergents and care agents specifically developed for the machines. These products meet the requirements of the German Detergent and Detergent Act (WRMG).

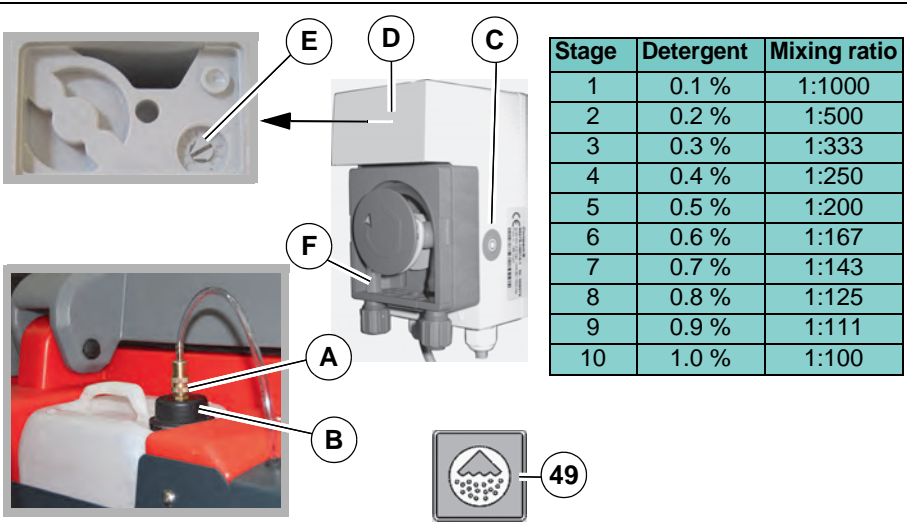

Fig. 19:

**Putting into service**

1. Release quick coupler **Fig. 19-A** at canister lid by pulling the lower ring of the coupling upwards. Unscrew lid from filled canister. Screw on lid with integrated hose **Fig. 19-B** and fit quick coupling with hose.
2. Turn the machine on with the key switch.
3. Switch on the dosing system using the *On-Board Dosing System* **Fig. 19-49** switch.
4. Press the quick ventilation switch **Fig. 19-C** at the dosing pump until detergent is present at the non-return valve.

**Setting the mixing ratio**

1. Remove the grey cover **Fig. 19-D** at the dosing pump.
2. Set the mixing ratio according to the detergent being used.
3. Basic setting = 1:700  
Set the rotary knob **Fig. 19-E** between setting 1 and setting 2, see table.

## Maintenance

Check the hose section **Fig. 19-F** in the hose pump (length approx. 23 mm) and replace if necessary.

### 3.4.3 Useful cleaning tips

Sweep the floor before carrying out wet cleaning. This not only enhances the cleaning effect but also reduces wear of the machine's working tools.

If the floors are really dirty or wax needs to be removed, treat the floor twice. In the first step, scrub the floor with a detergent suitable for the degree of soiling; the squeegee remains raised for this.

Leave the detergent for approx. 5 to 10 minutes; subsequently scrub the floor again and work with a lowered squeegee.



#### Note

- Only use detergents suitable for automatic machines (foam retarded). We recommend use of our detergents and care agents specifically developed for the machine. These products meet the requirements of the German Detergent and Cleaning Agent Act (WRMG).
- Observe correct dosing of the detergent. Correct dosing saves money and protects the environment. Strong foam formation is a sign of excessive dosing and impairs machine operation.

### 3.4.4 Handling and braking the vehicle



#### Note

Set the key switch to '0' to immediately disable all the functions.



#### Danger

- Danger of tilting over when driving on excessively steep slopes  
Transport journeys on slopes of up to 10 % must only take place for a limited period of time and with special caution.
- Risk of skidding when driving on wet surfaces.  
Drive very carefully into the bend when driving downhill.

Observe the following points when driving:

- Driving speed and braking of the machine are controlled via the accelerator pedal.
- The engine brake is automatically applied when the accelerator pedal is released. This also applies when ascending or descending.
- Stop the machine: Release the accelerator pedal.
- When the machine is at standstill, the parking brake is activated audibly. It is no longer possible to push the machine, see section 3.4.5.

#### Overload protection

In case of an overload, e.g. excessively steep slopes, the drive motor is switched off after a certain period of time.

- Let the machine cool down for approx. 15 minutes.
- Restart the machine.

### 3.4.5 Pushing the machine



#### Danger

Risk of accident! When pushing the machine, it does not have any braking effect.

Only push the machine on a level surface!

After pushing the machine, only re-start it if the lever has been positioned and the cover installed.

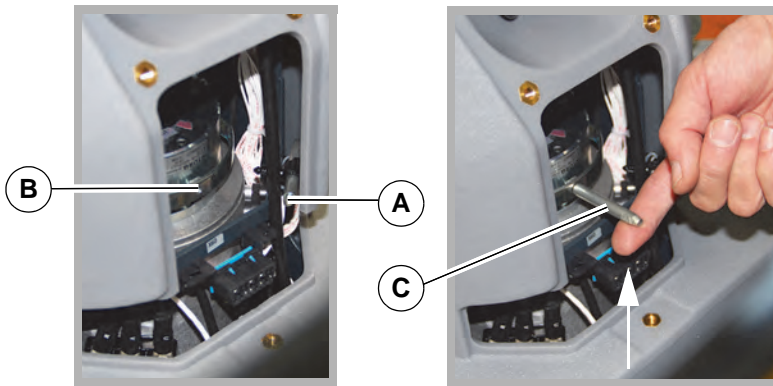

**Fig. 20:**

In order to push the machine, carry out the following steps:

1. Loosen the bolts of the cover to the drive using the supplied socket wrench and remove the cover.
2. Remove the pin **Fig. 20-A** from the holder and screw it into the ring **Fig. 20-B**.
3. In order to unlock the parking brake, pull the pin upwards slightly **Fig. 20-C** and simultaneously push the machine.
4. Disassembly is in reverse order.

### 3.4.6 Turning off the machine

1. Slowly bring the accelerator pedal to the zero position. The machine slows down to standstill. A better braking effect is achieved when the machine is slowed down by applying the brake.
2. When the machine is at standstill, the parking brake is activated audibly.
3. Switch off the cleaning functions.
4. Switch off the machine using the key switch.



**Note**

Remove the key when leaving the machine to prevent unauthorised use.

### 3.4.7 Check list: After cleaning



**Environmental danger**

Observe the applicable laws and local regulations when disposing of detergents.



**Attention**

Do not use a high-pressure cleaner or steam cleaner to clean the machine.

No.	Description
1	Drive to a suitable maintenance location.
2	Switch the machine off and pull out the key.
3	Empty and clean the waste water tank, see section 5.5.2.
4	Check the fresh water filter, see section 5.5.6.
5	Check the sealing strips and suction hose, see chapter Maintenance and Servicing.
6	Check the functions and settings.
7	Charge the battery, see section 5.3.2.
8	Clean the machine. If the machine is not used over a longer period of time, the solution tank must be fully emptied.



### 3.5 Loading and transporting



#### Attention

- When loading and subsequently transporting the machine to the work site, the squeegee and brush head must be raised.
- Risk of skidding! Drive very carefully and, if possible, only on dry ramps.
- To load the machine, reverse it up the ramp at idle speed (maximum slope 16 %).

#### Loading

When loading the machine, observe its weight, see Section 4 *Technical data*.

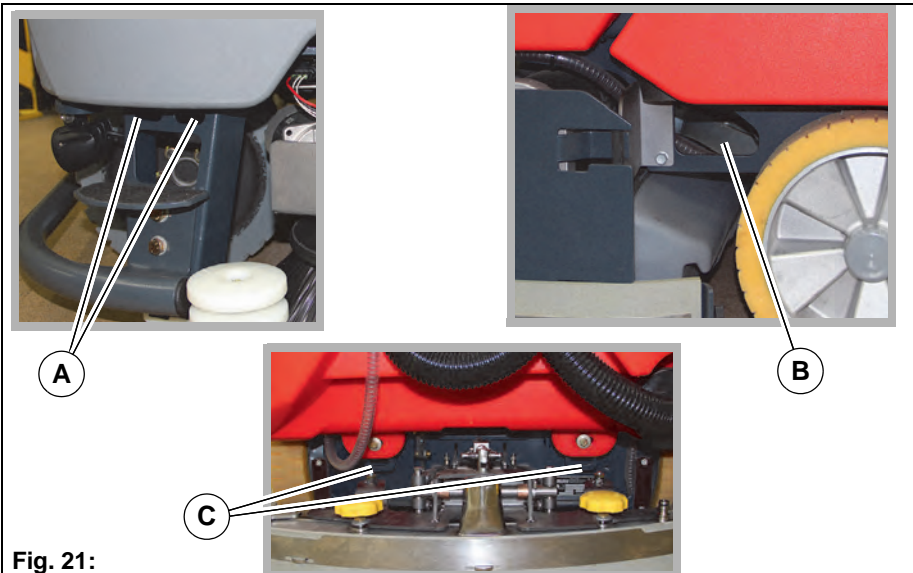

Fig. 21:

#### Transporting

When transported on a vehicle or trailer, the machine must be secured against tilting and rolling away. To do this, securely lash the machine at both side **Fig. 21-A**, at the side **Fig. 21-B** and the rear **Fig. 21-C** with tension straps.

### 3.6 Service information

In case problems occur with the machine, a four-digit service code is output in the display panel in addition to the service indicator (tool key).

Eliminate the cause or note down the service code and inform your authorised Hako service partner.

If the cause has been eliminated, the fault must be acknowledged via the key switch OFF/ON.

Service code	Fault	Cause	Remedy
1.2.2.1	Brushes/ Roller stop	Electrical defects	Notify service partner
1.2.5.1/ 1.2.5.2	Brushes stop	Foreign particles between brush and shaft	Inspect the brushes for foreign particles and remove them if necessary
1.2.6.1/ 1.2.6.8	Brushes stop	Foreign particles block the brush	Inspect the brushes for foreign particles and remove them if necessary
		Brush not positioned correctly in the holder	Actuate the brush decoupling system, contact the service partner, if necessary
1.2.6.3	Brush lift system, brush and suction turbine have been switched off	Foreign particles between brush head and machine	Inspect the brush head for foreign particles and remove them if necessary
		Brush head stuck	Release brush head
1.4.6.1	Squeegee lift system stops	Overload due to foreign particles	Inspect for foreign particles and remove them if necessary
		Foreign particles between squeegee and machine	Inspect the lift system for foreign particles and remove them if necessary
		Squeegee jammed	Make the squeegee accessible
1.4.6.3/ 1.4.6.4	Suction turbine stops	Foreign particles in the suction turbine	Notify service partner
		Faulty suction turbine	

<b>Service code</b>	<b>Fault</b>	<b>Cause</b>	<b>Remedy</b>
1.5.5.1	Fresh water level not displayed	Error in the electronics	Notify service partner
2.2.5.1	Rotating cylindrical brush stops	Foreign particles block the brush	Inspect the rotating cylindrical brush for foreign particles and remove them if necessary
3.2.6.6.	Service code indicator when turning on the machine	Discharged capacity of the internal back-up battery of the machine control	Notify service partner
3.3.1.1	Service interval expired		See maintenance plan
3.4.1.2/ 3.4.1.3	Driving not possible	Error in the drive control	Turn the machine OFF/ON, contact the customer service if necessary
3.4.5.1.	Cleaning function switches off	Drive wheel becomes sluggish due to foreign particles	Remove foreign particles
		Drive motor overheats	Let the engine cool down
3.6.6.4.	Driving and cleaning not possible	Seat permanently loaded	Relieve seat
5.8.7.1.	Batteries are not being charged	Mains plug not inserted correctly	Insert the mains plug correctly
5.8.7.2	Batteries are not being charged	Cables on the battery poles loose or detached	Contact the customer service
		Incorrect type of battery installed	Install correct battery

7.1.5.1	USB connection not working	Connected consumer overloaded	Check whether the consumer is drawing too much power or there is a short-circuit in the connected cable.
		Internal controller defect	Notify service partner

## 4 Technical data

### Dimensions

Name	Unit	TB 900	TB 1080	WB 850
Length of machine with squeegee without/with pre-sweep unit	mm	1890/2670	1890/2670	1890
Width of machine without/with squeegee	mm	940/1130	1120/1290	940/1130
Height of machine without/with driver protection roof	mm	1450/2080		

### Working width

Brush unit	mm	900	1080	850
Squeegee	mm	1100	1260	1100

### Weights

Weight (empty, without batteries)	kg	450	455	440
Total weight (ready for use)	kg	1010	1015	1100
Permissible total weight	kg	1310		

### Driving performance

Driving speed transportation (forwards/reverse)	km/h	8/4		
Climbing capacity when cleaning	%	6 (2 min)		
Climbing capacity during transport journey (ready for operation)	%	10 (1 min)		
Ramp angle/Slope angle	%	16		
Turning circle (with squeegee)	mm	2960	2970	2960

### Wheels

Wheel diameter	mm	305		
Specific wheel contact pressure front/rear	N/mm <sup>2</sup>	0.66/0.65		

### Tank contents

Name	Unit	TB 900	TB 1080	WB 850
Solution tank	Litre	175		
Waste water tank	Litre	175		

### Brush head

Brush speed	rpm	210	210	850
Min./Max. brush pressure	kg	35/70	38/70	29/38

### Vacuum system

Air quantity 1/2 suction turbine	m <sup>3</sup> /h	100/200	200	100/200
Vacuum (maximum)	mbar	approx. 50		

### Electrical system

Nominal voltage	V	36		
Nominal output (max.) (P1)	W	7470		
Power consumption drive motor (P1) S2-120 min	W	2335		
Power consumption of vacuum motor (P1) 1/2 suction turbine	W	641/1282	1282	641/1282
Power consumption brush motor (P1)	W	2x936	2x936	2x918
Power consumption water pump (P1)	W	approx. 67		
Type of protection		IPX 3		
Protection class		III		

### On-board charger

Rated input/output voltage	V	230/36		
Nominal output	W	1600		
Type of protection		IPX 3/P20		
Protection class		I		

**Noise emission value**

		B175 R WZB		B175 R TB	
		Standard operation	Silent operation	Standard operation	Silent operation
The sound power level ( $L_{wAd}$ ) measured under the customary conditions of use according to DIN EN 60335-2-72 is:	dB (A)	85	80	85	80
The sound pressure level ( $L_{pA}$ ) (at the ear of the driver) measured under the customary conditions of use according to DIN EN 60335-2-72 is:	dB (A)	68	64	68	64
Measuring uncertainty ( $K_{pA}$ )	dB (A)	1.4	1.5	1.6	1.3

**Vibration**

Under the customary conditions of use, the weighted effective value of the acceleration to which the upper limbs (hand-arm) are subjected to according to DIN EN ISO 5349 is:	$m/s^2$	$\leq 2,5$
Under the customary conditions of use, the weighted effective value of the acceleration to which the body (feet or seat surface) is subjected to DIN EN ISO 2631-1 is:	$m/s^2$	$\leq 0,5$

## 5 Maintenance and Servicing

### General

The operator is instructed fully on delivery of the machine.



#### Attention

Before undertaking servicing and maintenance work, read and observe the safety instructions in chapter 1 of this operating manual!

Compliance with the maintenance work recommended by us gives you the certainty of always having an operational machine available.

Daily and weekly maintenance and repair work can be undertaken by a driver trained for this, all further Hako system maintenance work may be undertaken only by trained and qualified personnel.

Please contact your nearest Hako service centre or authorised Hako dealer. Any warranty claim is null and void if this is not complied with and damage results.

Please always state the serial number in all enquiries and spare parts orders, see section 1.7 – type plate.

### Hako system maintenance

The Hako system maintenance specifies in single modules the special technical work to be done and the periods of time for the maintenance activities.

Parts to be replaced for the individual maintenance tasks are determined.

Hako system maintenance:

- Assures the reliable readiness for use of the Hako cleaning machines (preventive maintenance).
- Minimises operating costs, repair costs, costs for maintenance.
- Assures long life and readiness for use of the machine.



#### Note

Maintenance parts in the machine are marked with a yellow dot and yellow areas.



### 5.1 Maintenance certificate

<p><b>Handover</b></p> <p>Equipment Trial run Handover to customer Instruction performed on: at _____ operating hours</p>	<p><b>Hako system maintenance I 250 operating hours</b> Workshop stamp</p> <p>performed on: at _____ operating hours</p>	<p><b>Hako system maintenance II 500 operating hours</b> Workshop stamp</p> <p>performed on: at _____ operating hours</p>
<p><b>Hako system maintenance I 750 operating hours</b> Workshop stamp</p> <p>performed on: at _____ operating hours</p>	<p><b>Hako system maintenance S 1000 operating hours</b> Workshop stamp</p> <p>performed on: at _____ operating hours</p>	<p><b>Hako system maintenance I 1250 operating hours</b> Workshop stamp</p> <p>performed on: at _____ operating hours</p>
<p><b>Hako system maintenance II 1500 operating hours</b> Workshop stamp</p> <p>performed on: at _____ operating hours</p>	<p><b>Hako system maintenance I 1750 operating hours</b> Workshop stamp</p> <p>performed on: at _____ operating hours</p>	<p><b>Hako system maintenance S 2000 operating hours</b> Workshop stamp</p> <p>performed on: at _____ operating hours</p>
<p><b>Hako system maintenance I 2250 operating hours</b> Workshop stamp</p> <p>performed on: at _____ operating hours</p>	<p><b>Hako system maintenance II 2500 operating hours</b> Workshop stamp</p> <p>performed on: at _____ operating hours</p>	<p><b>Hako system maintenance I 2750 operating hours</b> Workshop stamp</p> <p>performed on: at _____ operating hours</p>
<p><b>Hako system maintenance S 3000 operating hours</b> Workshop stamp</p> <p>performed on: at _____ operating hours</p>	<p><b>Hako system maintenance I 3250 operating hours</b> Workshop stamp</p> <p>performed on: at _____ operating hours</p>	<p><b>Hako system maintenance II 3500 operating hours</b> Workshop stamp</p> <p>performed on: at _____ operating hours</p>

## 5.2 Maintenance plan

### Hako system maintenance customer:

Work to be performed by the customer by reference to the servicing and maintenance instructions specified in the operating manual.

Daily
<ul style="list-style-type: none"><li>Emptying the waste water tank</li><li>Clean the waste water tank, drain hose, coarse dirt sieve and suction filter</li></ul>
<ul style="list-style-type: none"><li>Check the cover seal of the waste water tank, clean if necessary</li></ul>
<ul style="list-style-type: none"><li>Check the battery, charge if necessary</li></ul>
<ul style="list-style-type: none"><li>Check the squeegee, clean if necessary</li></ul>
<ul style="list-style-type: none"><li>Emptying the dirt hopper in the roller brush unit (optional)</li></ul>
Weekly
<ul style="list-style-type: none"><li>Clean the machine as required</li></ul>
<ul style="list-style-type: none"><li>Clean the solution tank</li></ul>
<ul style="list-style-type: none"><li>Check the sieve insert in the fresh water filter, clean or replace if necessary</li></ul>
<ul style="list-style-type: none"><li>Check the scrubbing performance of the brushes/pads, clean if necessary</li></ul>
<ul style="list-style-type: none"><li>Check the brushes and water retaining ring for proper fit and wear, replace if necessary</li></ul>
<ul style="list-style-type: none"><li>Check the suction performance of the squeegee, clean or replace the sealing strips if necessary</li></ul>
<ul style="list-style-type: none"><li>Check the fresh water supply to the brushes, clean if necessary</li></ul>
<ul style="list-style-type: none"><li>Check the suction hose for tight fit and damage, clean if necessary</li></ul>
<ul style="list-style-type: none"><li>Check the rubber of the lateral wiper, replace if necessary</li></ul>
<ul style="list-style-type: none"><li>Pre-sweep unit (optional), check rotating cylindrical brush, clean if necessary</li></ul>
<ul style="list-style-type: none"><li>Trial run and function test</li></ul>

### Hako system maintenance I:

Performance by an expert of an authorised Hako workshop by reference to the machine-specific system maintenance.

Every 250 hours
<ul style="list-style-type: none"> <li>• Check the battery and the charger</li> <li>• Check the battery acid level and acid density, refill demineralised water if necessary</li> <li>• Check the air inlet grilles, air duct and filter mat of the on-board charger for contamination, clean or replace if necessary</li> </ul>
<ul style="list-style-type: none"> <li>• Check steering for stiffness and play</li> <li>• Check steering pinion and gear rim for damage, grease if necessary.</li> </ul>
<ul style="list-style-type: none"> <li>• Check the brake for proper functioning</li> </ul>
<ul style="list-style-type: none"> <li>• Check the cover seal of the waste water tank, replace if necessary</li> <li>• Check operation of float switch in waste water tank.</li> <li>• Check the waste water and suction system, replace worn parts if necessary</li> </ul>
<ul style="list-style-type: none"> <li>• Check the fresh water supply, replace worn parts if necessary</li> </ul>
<ul style="list-style-type: none"> <li>• Check the sealing strip/slot strip of the squeegee, turn or replace if necessary</li> <li>• Check the deflecting bracket/deflecting rollers at the squeegee, replace if necessary</li> <li>• Check the squeegee setting, reset if necessary</li> </ul>
<ul style="list-style-type: none"> <li>• Check the sieve insert and cover seal of the fresh water filter for damage, replace if necessary</li> </ul>
<ul style="list-style-type: none"> <li>• Check the seal at the drain hose, replace if necessary</li> </ul>
<ul style="list-style-type: none"> <li>• Check the condition of tyres</li> <li>• Check the rear wheel mounting screws, re-tighten if necessary (42 Nm)</li> </ul>
<ul style="list-style-type: none"> <li>• Check the electrical system (lighting, fuses and relays), replace parts if necessary</li> </ul>
<ul style="list-style-type: none"> <li>• Remove fluff and dirt from the air inlet grilles of the brush motors</li> </ul>
<ul style="list-style-type: none"> <li>• Check toothed belt and bearing of the roller brush unit, replace if necessary</li> </ul>
<ul style="list-style-type: none"> <li>• Check V-belt drive of pre-sweep unit (optional)</li> <li>• Check the rotary brush setting, reset if necessary</li> </ul>
<ul style="list-style-type: none"> <li>• Check the side brush setting (optional), reset if necessary</li> </ul>
<ul style="list-style-type: none"> <li>• Check the front collision protection with deflecting roller for damage</li> </ul>

### **Hako system maintenance I (continued):**

<b>Every 250 hours</b>
Spray the following locations on the machine with penetrating lubricant: <ul style="list-style-type: none"><li>• Hinges at the squeegee lift system</li><li>• Hinges at the side deflectors</li><li>• Hinge and joint locations of the brush lift system</li></ul>
<ul style="list-style-type: none"><li>• Check the optical condition of the machine (corrosion and labels)</li></ul>
<ul style="list-style-type: none"><li>• Trial run and function test</li></ul>

### **Hako system maintenance II:**

Performance by an expert of an authorised Hako workshop by reference to the machine-specific system maintenance.

<b>Every 500 hours</b>
<ul style="list-style-type: none"><li>• All maintenance work according to Hako system maintenance I</li></ul>
<ul style="list-style-type: none"><li>• Read out the error memory and evaluate the service information</li></ul>
Check the following electrical output: <ul style="list-style-type: none"><li>• Drive motor</li><li>• Brush motors</li><li>• Suction turbines</li><li>• Pre-sweep unit (optional)</li><li>• Side brush unit (optional)</li></ul>
<ul style="list-style-type: none"><li>• Trial run and function test</li></ul>

### **Hako system maintenance III/S (safety check)**

Performance by an expert of an authorised Hako workshop by reference to the machine-specific system maintenance. Performance of all legally stipulated safety-relevant tests according to the BGV specifications.

<b>Every 1000 hours</b>
<ul style="list-style-type: none"><li>• All maintenance work according to Hako system maintenance II</li></ul>
<ul style="list-style-type: none"><li>• Replace the backup battery of the electrical control and set a real-time clock</li></ul>
<ul style="list-style-type: none"><li>• Remove coal dust from the brush motors, the side brush unit motor and the pre-sweep unit motor and check the carbon brushes for ease of movement and wear, replace carbon brushes if necessary</li></ul>
<ul style="list-style-type: none"><li>• Trial run and function test</li></ul>







## 5.3 Battery

### 5.3.1 Checking the charging state



Fig. 22:

The charge condition of the battery is displayed on the MFD during operation. Depending on the charge condition, the following symbols appear:

Symbols	Charging state	Notes
	Battery is fully charged	
 to 	Battery capacity is displayed in steps of 10 %	Battery can be charged
	Battery capacity less than 10 %	Cleaning functions are switched off after 3 minutes. Charge the battery!
	Battery is empty	Cleaning functions will be switched off. Only travel at half speed is possible. Battery must be fully charged immediately!
	BMS service information. A four-digit service code appears at the same time <b>Fig. 22-B</b>	Service information, see section 3.6

### 5.3.2 Charge the battery



#### Warning

- Risk of explosion! Explosive gases can develop when charging the battery.  
Avoid smoking, fire or naked light in the vicinity of batteries. Ensure that there is sufficient ventilation when charging the battery. Do not inhale battery gases!
- Danger of explosion due to short circuits and spark formation! Never place tools or other electrically conductive objects on the battery!

#### Attention

- Before initially starting up the machine, the battery that is used must be fully and properly charged with commissioning charge. Please observe the instruction manual of the charging device and the instruction manual of the battery manufacturer. Hako assumes no liability for battery damage resulting from insufficient commissioning charge.
- Never leave batteries discharged, always recharge them immediately.
- If possible, charge the batteries fully to ensure that the batteries have an optimum service life. The charger is designed as a continuous charger and retains the charging state of the battery (trickle charge) after completing the charging process.
- The battery should always be charged without being interrupted.
- During the charging process it is not possible to turn on the machine.
- Swivel up the seat console all the way before charging the battery.  
The seat console must remain open when charging the battery!

### Charging the battery with the on-board charger

The battery is charged via the integrated on-board charger. A battery charge is recommended when the charge condition is low, but no later than when the cleaning functions are shut off.

1. Place the machine on a level surface and turn it off.
2. Remove the mains plug **Fig. 4-20** from the tray and plug it into a 230 V socket.
3. The charging process now starts automatically.

### Checking the charging process

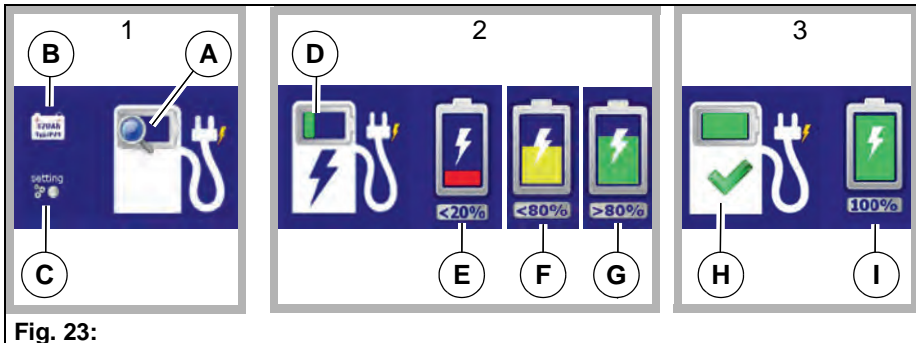

**Fig. 23:**

During the charging process, the progress of the charging is displayed in the MFD:

- 1 Once the mains plug has been plugged in, the initialisation phase starts and the symbol *Charger with surrounding magnifying glass* **Fig. 23-A** is displayed. The information about the type of battery which has been installed
  - appears to the left of this **Fig. 23-B** and
  - the charge characteristic which has been set **Fig. 23-C**.
- 2 Charging starts, and is indicated by a bar that is continuously filled **Fig. 23-D**. At the same time, the battery capacity that has already been stored appears to the right of this in three symbols:
  - Symbol *battery capacity less than 20 %* **Fig. 23-E**
  - Symbol *battery capacity less than 80 %* **Fig. 23-F**
  - Symbol *battery capacity more than 80 %* **Fig. 23-G**
- 3 The end of charging is indicated by the following symbols:
  - Symbol *charger with green tick and filled bar* **Fig. 23-H**
  - Symbol *battery capacity 100 %* **Fig. 23-I**

The charger switches to trickle charging.





## Warning symbols during the charging procedure

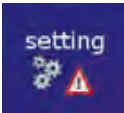

### Note

Failure to pay attention to warning symbols can lead to damage to the charger or the battery.

If a fault occurs during the charging procedure, the red service spanner appears in the toolbar with a 4-digit service code. An acoustic warning is also heard for approx. 30 seconds. A warning symbol appears in the MFD.

Warning symbols/service code	Possible cause	Remedy
	Wrong battery or no battery	Check battery
	Battery connector not connected	Check battery connector
	Invalid charge characteristic	Contact the customer service
		Contact the customer service
	Charger temperature too high e.g. due to sunshine	Disconnect the mains plug. Move the machine to a cooler, shaded location. Wait for 1/2 hour, then continue charging.
	Air filter for cooling is soiled.	Have air filter cleaned by Hako service
	Fault in communication connection	Contact the customer service
	Charging phase time exceeded	Disconnect mains plug and restart the machine.



## Charging the battery with a stationary charger

**Attention**

Observe the information in the instruction manual of the charger manufacturer!

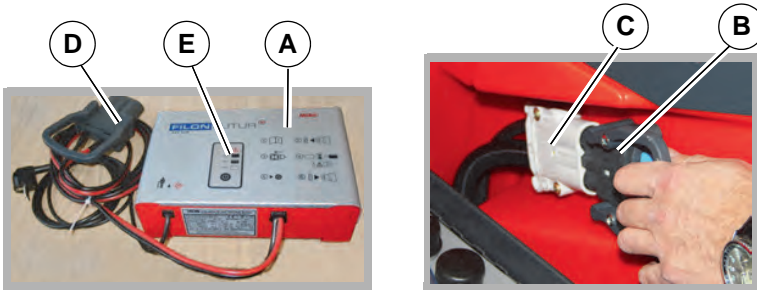

**Fig. 24:**

Charge the batteries with a stationary charger as, for example, shown in **Fig. 24-A**. The batteries can be charged if the battery capacity is less than 60 %.

1. Place the machine on a level surface and turn it off.
2. Disconnect the battery plug **Fig. 24-B** from the machine plug **Fig. 24-C**.
3. Connect the battery plug to the plug of the charger **Fig. 24-D**.
4. Switch on the charger.
5. The progress of the charging process is displayed in the display **Fig. 24-E** of the charger. The charge control indicator in the MFD of the machine is not active during charging with the stationary charger!
6. Once the battery is fully charged, terminate the charging process:
  - Switch off the charger.
  - Disconnect the battery plug from the plug of the charger and reconnect it to the plug of the machine **Fig. 24-C**.

### 5.3.3 Checking the acid level



#### Warning

Risk of explosion and fire! When handling batteries, it is prohibited to smoke and use an open fire.

#### Attention

- Observe the information in the operating manual of the battery manufacturer!
- Refilling must only take place once the battery charging process has been terminated.

#### Note



Batteries approved by Hako are equipped with an aquamatic system.

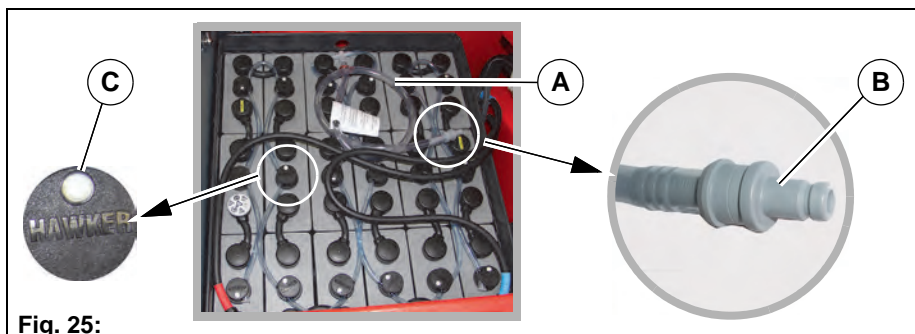

Fig. 25:

The customer has to check the acid level of the battery weekly, demineralised water (according to DIN 43530-4) must be refilled if necessary.

#### Checking the acid condition:

If the trough battery is equipped with an aquamatic system **Fig. 25-A**, each individual cell features a sealing plug with float indicator.

The white dot must be located at the top and must be clearly visible. If this is not the case, refill demineralised water.

#### Topping up with demineralised water:

Connect the end piece of the aquamatic system **Fig. 25-B** to a container with demineralised water. Observe sufficient gradient, ensuring the water can flow into the cells. Once the required filling level has been reached, the plugs automatically seal the cells and indicate “full” **Fig. 25-C**.

### 5.3.4 Replacing the battery



#### Attention

- Only use batteries approved by Hako at the intended position!
- The battery should only be replaced by qualified service personnel!
- Wear safety shoes when changing the battery.
- Only change the battery using suitable lifting gear and crane gear with a sufficient load-bearing capacity.
- Lifting hooks may not cause damage to cells, connectors or connecting cables!
- When using other batteries which have been approved by Hako, the BMS must be reset to protect the battery against total discharge. The settings of the BMS should only be carried out by a workshop authorised by Hako!

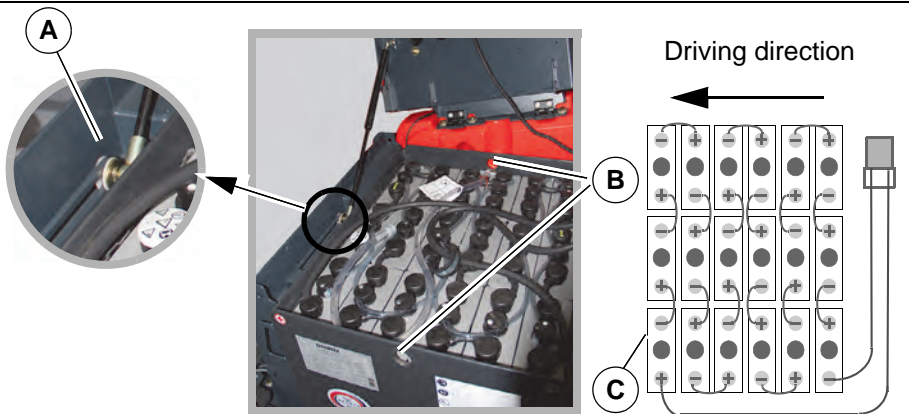

Fig. 26:

#### Removing the battery

1. Place the machine on a level surface and turn it off.
2. Undo the side panelling of the machine with the provided spanner and remove.
3. Open the seat console all the way **Fig. 26-A**.
4. Disconnect the battery plug.
5. Attach crane gear to eyelets of the battery trough **Fig. 26-B**.  
The crane gear must carry out a vertical pull so that the battery trough is not distorted.
6. Slowly lift the battery trough upwards and swivel out to the side.

Assembly is in reverse order.



**Note**

Please ensure that the trough battery is in the correct installation position! See connecting diagram **Fig. 26-C**.

### 5.3.5 Battery plug coding

When using other batteries which have been approved by Hako, the plugs must be re-coded.

The plug connectors between the battery **Fig. 27-A**, the machine **Fig. 27-B** and the charger **Fig. 27-C** are coded with coloured coded pins (yellow, grey or green) **Fig. 27-D** depending on the type of battery and rated voltage.

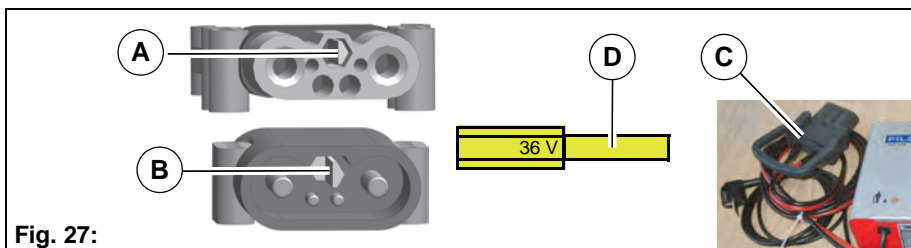

**Fig. 27:**

The following three prerequisites must be met for the whole system:

- Voltage coding (36 V) must be identical for all plugs and bushes.
- The colour of the coded pin in the connector housing of the machine is always yellow.
- The colour of the coded pin in the charger plug (machines without built-in charger) and in the bush housing of the battery must be identical:
  - Grey for wet batteries
  - Green for maintenance-free gel batteries



**Warning**

Risk of short circuit! The coding of the plugs should only be carried out by a workshop authorised by Hako!

### 5.3.6 Maintaining drive batteries

For maintaining and servicing drive batteries, see Hako supplementary sheet 88-60-2556 – information for drive batteries.

### 5.3.7 Taking the machine out of service for a long period

If the battery is not used for more than three months, the battery must be recharged.



**Note**

Only park unused machines if they are switched off, have a fully charged battery and are placed in a dry location.

### 5.3.8 Disposing of batteries

Used batteries with the recycling symbol contain reusable commodities. They must not be disposed of in domestic waste, see Section 1 *Environmental protection instructions and disposal*.

## 5.4 Solution tank

The filling level in the solution tank is measured continuously and shown in the MFD in steps of 20 %. If there are less than 10 litres in the tank, a warning symbol appears in the **Fig. 28-A** MFD. At the same time, an acoustic warning is heard and indicates that a top-up is required.



Fig. 28:

### 5.4.1 Filling the solution tank

Fill the solution tank **Fig. 28-25** through the filling opening before commencing work or as required **Fig. 28-B**.



#### Attention

In order to avoid contamination of the drinking water by backflow, the requirements of DIN EN1717 must be adhered to for filling the solution tank.



#### Note

If the machine is equipped with an on-board dosing system, no detergent must be added to the fresh water!

### Filling the solution tank with a hose

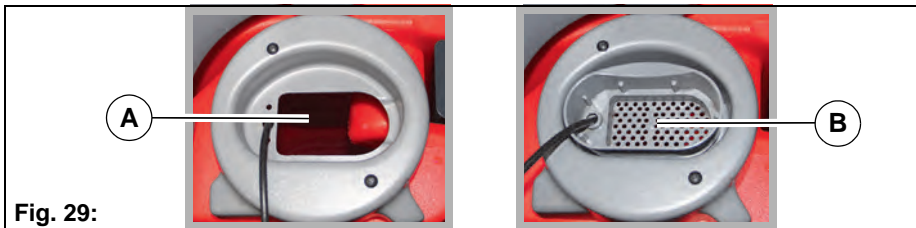
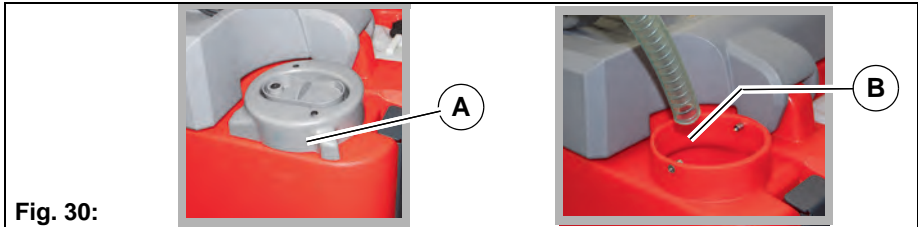

Fig. 29:

1. Place the machine on a level surface.
2. Remove insert in grey cover **Fig. 29-A**.
3. Fill the solution tank up to approx. 15 cm below the maximum filling level (maximum water temperature 50 °C).
4. Add detergent according to the manufacturer's regulations via the sieve insert **Fig. 29-B**.

### Filling the solution tank with the fast fill station

The filling opening of the solution tank can be increased when filling with the fast fill station by unscrewing the grey cover **Fig. 30-A** and removing it **Fig. 30-B**.



**Fig. 30:**

### Filling the solution tank with the automatic filling unit

Optionally, the solution tank can be filled via the automatic filling unit.

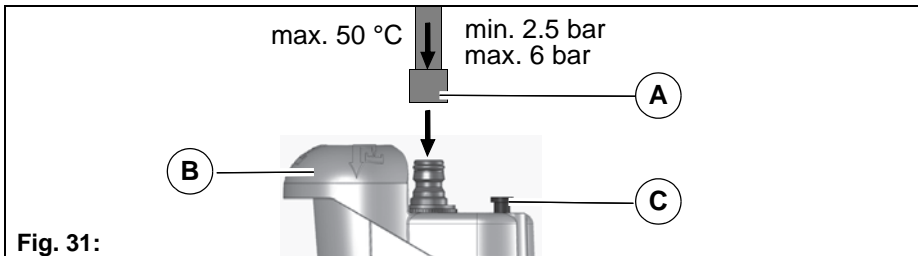

**Fig. 31:**

1. Fit the hose with the quick coupler **Fig. 31-A**. Do not yet open the water supply!
2. Push the operating button **Fig. 31-B**. The indicator knob **Fig. 31-C** protrudes.
3. Open the water supply – water starts to flow.
4. The filling unit switches off automatically when the tank is full. The indicator knob **Fig. 31-C** no longer protrudes.
5. Close the water supply and remove the hose with the quick coupling.  
Use a water line fitted with a stop valve!



#### Note

The machine can also be filled manually through the opening in the operating button **Fig. 31-B**.

## 5.4.2 Emptying the solution tank

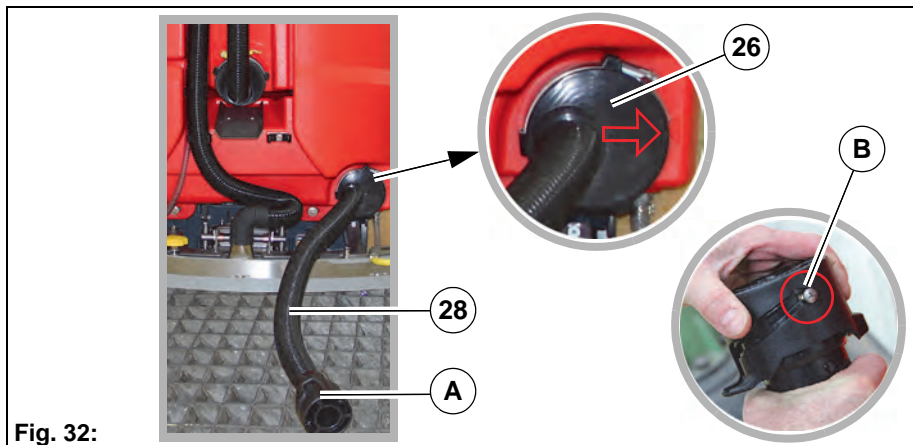

Fig. 32:

1. Drive to a suitable disposal centre.
2. Position the machine, ensuring the drain hose **Fig. 32-28** reaches the drain in the ground.
3. Turn off the machine.
4. Remove the drain hose from the holder, open the drain valve **Fig. 32-A** and drain the waste water tank via the drain.
5. Ensure that the drain hose closure is fully closed after draining **Fig. 32-B!**

## 5.4.3 Cleaning the solution tank

1. Empty the solution tank, see section 5.4.2.
2. Undo the screw clamp with a screwdriver and remove the drain hose **Fig. 32-28**.
3. Lead the water hose through the maintenance opening **Fig. 32-26** and clean the solution tank thoroughly.
4. Position the drain hose onto the support of the maintenance opening (arrow must point to the right) and close again securely using the screw clamp.



## 5.5 Waste water tank

### 5.5.1 Emptying the waste water tank

Clean the waste water tank **Fig. 34-38** daily or as required. When the symbol *Waste water tank full* **Fig. 33-A** appears in the display panel and an acoustic warning signal is output, the suction functions are switched off and the waste water tank should be drained immediately.



#### Environmental danger

Observe applicable laws and local regulations when disposing of detergents!

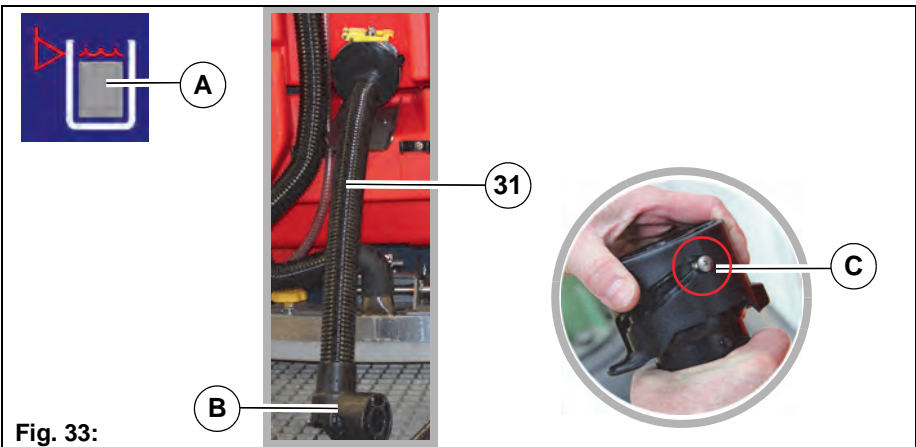
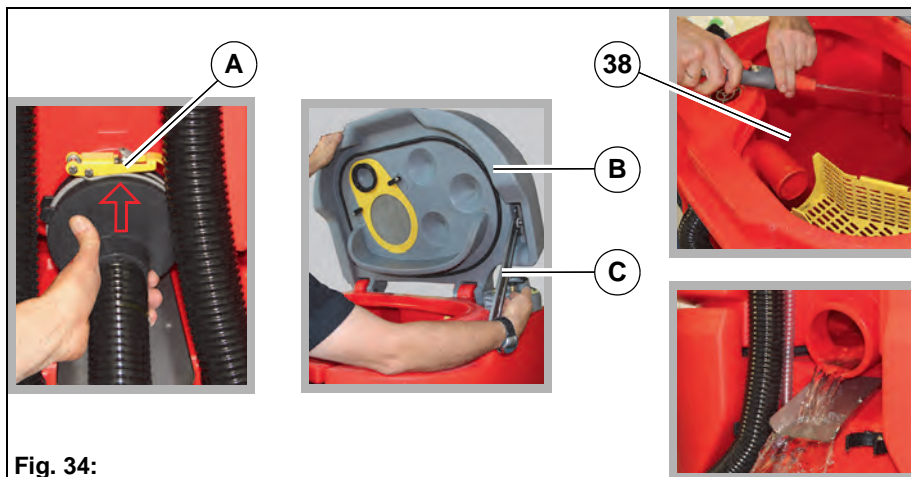

**Fig. 33:**

1. Drive to a suitable disposal centre.
2. Position the machine, ensuring the drain hose **Fig. 33-31** reaches the drain in the ground.
3. Turn off the machine.
4. Remove the drain hose from the holder, open the drain valve **Fig. 33-A** and drain the waste water tank via the drain.
5. Ensure that the drain hose closure is fully closed after draining!

## 5.5.2 Cleaning the waste water tank

Clean the waste water tank daily or as required.

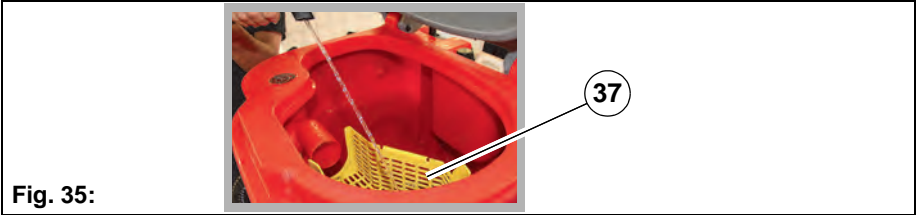

**Fig. 34:**

1. Empty the waste water tank, see section 5.5.1.
2. Open fastener at drain hose **Fig. 34-A** and remove hose.
3. Open the tank cap **Fig. 34-B** of the waste water tank.
  - Reach into the recessed grip of the tank cap with one hand.
  - Open the tank cap until the support **Fig. 34-C** engages.
4. Clean the waste water tank thoroughly with the water hose/spray nozzle **Fig. 34-D**.
5. Also flush the drain hose.
6. Close the tank cap:
  - Reach into the recessed grip with one hand and open the tank cap a little further.
  - Release the support **Fig. 34-B** with your right hand and close the tank cap.
7. Position the drain hose on the neck of the maintenance opening (arrow must point upwards) and securely close using the fastener.

### 5.5.3 Cleaning the coarse dirt sieve

A coarse dirt sieve **Fig. 35-37** is optionally located in the waste water tank. Clean the sieve daily and as required.



**Fig. 35:**

### 5.5.4 Cleaning the intake sieve

Check the function of the intake sieve **Fig. 36-39** daily and clean it as required.

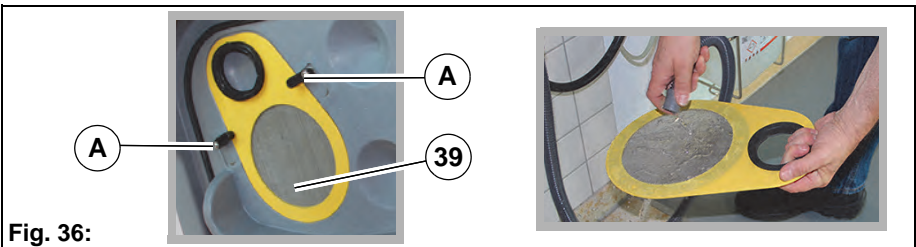

**Fig. 36:**

1. Rotate the locks **Fig. 36-A** downwards and remove the intake sieve **Fig. 36-39**.
2. Thoroughly clean the intake sieve under running water.

### 5.5.5 Checking the seal at the drain valve

Check the function of the seal in the drain valve **Fig. 37-A** daily, replace it after 125 operating hours at the latest.

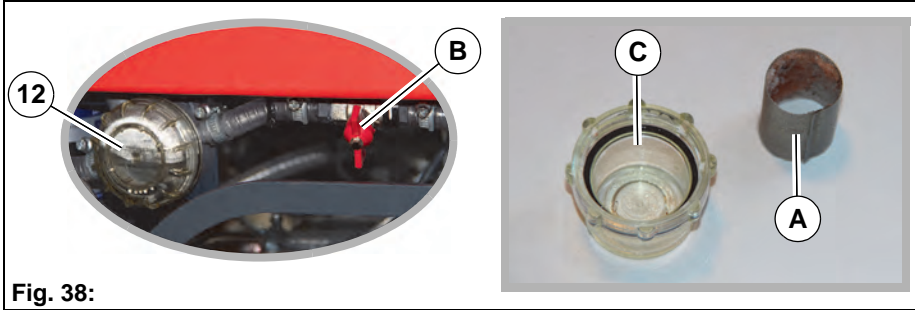

**Fig. 37:**

1. Twist drain valve by 90° and swivel down from drain hose.
2. Change the seal.
3. Grease seal and cone with Molykote.

### 5.5.6 Cleaning the fresh water filter

Check the filter sieve **Fig. 38-A** of the fresh water filter **Fig. 38-12** weekly and clean or replace it as required.



**Fig. 38:**

1. Close the ball cock **Fig. 38-B**.
2. Turn and remove the filter cover **Fig. 38-C**.
3. Remove the filter sieve **Fig. 38-A** from the filter housing and clean it under running water. Replace the filter sieve as required.
4. Reinsert the filter sieve and filter cover and open the ball cock.

### 5.5.7 Checking the seal in the tank cap

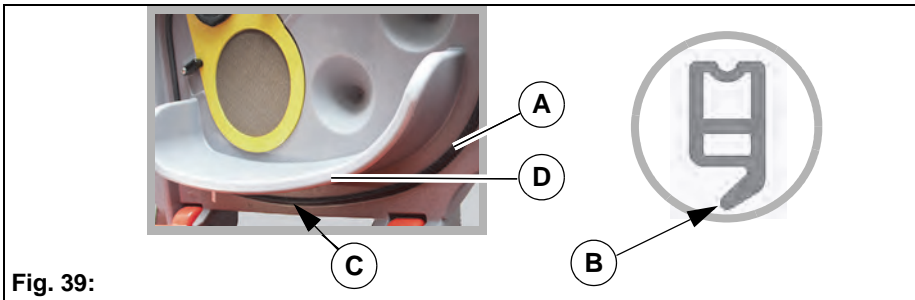

**Fig. 39:**

Check the function of the seal in the tank cap **Fig. 39-A** daily and replace it if damaged.

When replacing the seal:

- pay attention to correct installation position – sealing lip **Fig. 39-B** must be facing outwards,
- ensure that the disconnection point of the seal finishes edge to edge – the disconnection point **Fig. 39-C** must be below the dripping edge of the cover **Fig. 39-D**,
- ensure that the seal is pressed fully into the groove.

## 5.6 Rotating brush unit

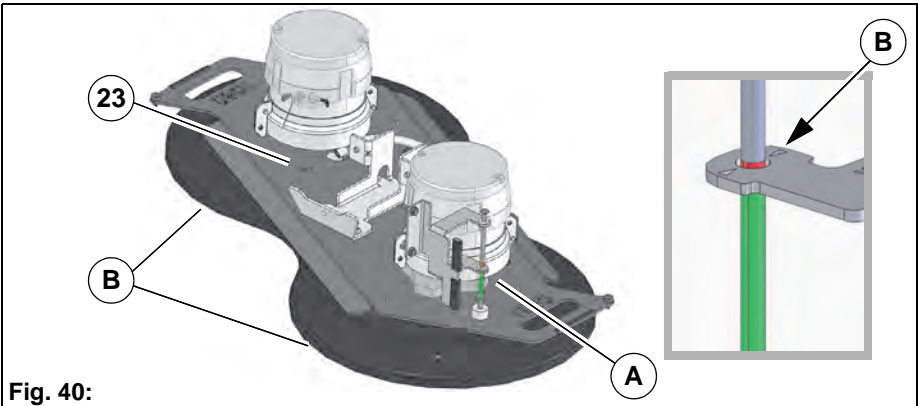

**Fig. 40:**

### 5.6.1 Replacing the brushes/pads

Use the indicator **Fig. 40-A** on the rotating brush unit to:

- determine the wear of the brushes/pads (the rotating brush unit must be lowered)
- determine whether the brushes/pads have been assembled.

The brushes/pads must be changed when the pointer **Fig. 40-B** is in the red zone at the latest.

1. Ejecting the brushes/pads, see section 5.6.3
2. Inserting new brushes/pads, see section 5.6.4



#### **Attention**

If no brushes/pads are fitted, the top edge of the display plate is outside the coloured area.

### 5.6.2 Cleaning the brushes

Clean the brushes **Fig. 40-B** in the rotating brush unit **Fig. 40-23** daily or as required.

1. Ejecting the brushes, see section 5.6.3
2. Thoroughly clean the brushes under running water.
3. Coupling the brushes, see section 5.6.4

### 5.6.3 Ejecting the brushes/pads

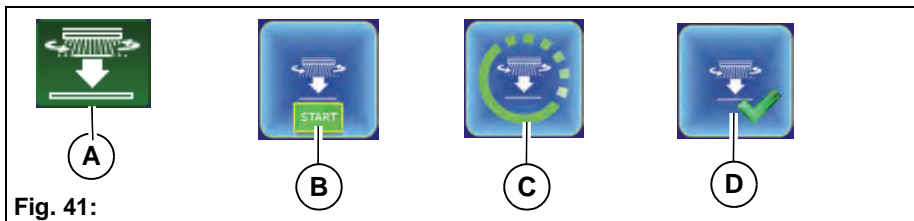

1. Make sure that the rotating brush unit has been raised and the machine is stationary.
2. Select soft key *Eject brushes* **Fig. 41-A** using the turn-push knob and confirm. The action window **Fig. 41-B** opens. Confirm the start with the turn-push knob.  
The procedure starts and symbols **Fig. 41-C, D** appear on the MFD one after the other. Only now is the procedure complete.
3. Swivel down the wiper see section 5.10.1 and remove the brushes/pads.

### 5.6.4 Coupling the brushes/pads

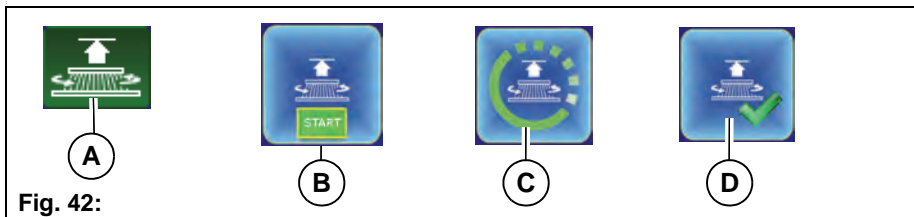

1. Make sure that the rotating brush unit has been raised and the machine is stationary.
2. Place the brushes/pads in a central position underneath the brush head holder.
3. Close the side wiper.
4. Sit on the seat and switch on the machine.
5. Select soft key *Insert brushes* **Fig. 42-A** with the turn-push knob and confirm. The action window **Fig. 42-B** opens. Confirm the start with the turn-push knob.  
The procedure starts and symbols **Fig. 42-C, D** appear on the MFD one after the other. Only now is the procedure complete.

## 5.7 Roller brush unit



### Attention

Only operate the drive with the dirt hopper inserted **Fig. 43-A**.

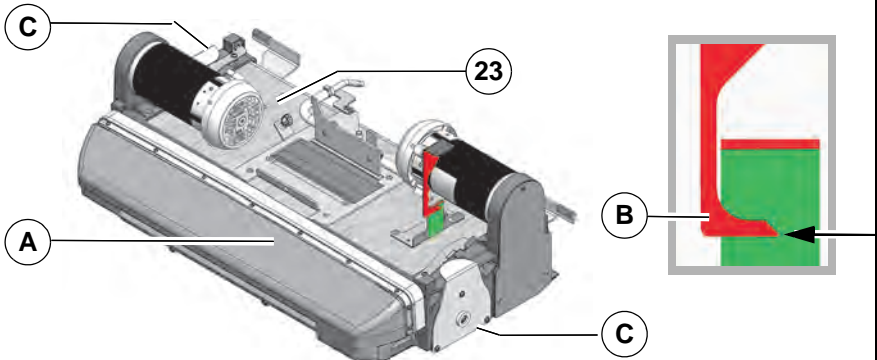

**Fig. 43:**

### 5.7.1 Emptying the dirt hopper

Empty the dirt hopper **Fig. 44-A** daily or as required.



**Fig. 44:**

1. Turn off the machine.
2. Swing down the wiper on the right-hand side of the machine.
3. Reach into the recessed grip below the dirt hopper with one hand and remove the dirt hopper **Fig. 44-A**.
4. Empty the dirt hopper.
5. Assembly is in reverse order.

### 5.7.2 Replacing the brushes

The brushes must be changed when the pointer in the indicator **Fig. 43-B** is in the red zone at the latest.

1. Disassemble the brushes, see section 5.7.4.
2. Install the brushes, see section 5.7.5.

### 5.7.3 Cleaning the brushes

Clean the brushes **Fig. 43-C** in the roller brush unit **Fig. 43-23** daily or as required.

1. Disassemble the brushes, see section 5.7.4.
2. Thoroughly clean the brushes under running water.
3. Install the brushes, see section 5.7.5.

### 5.7.4 Disassembling the brushes

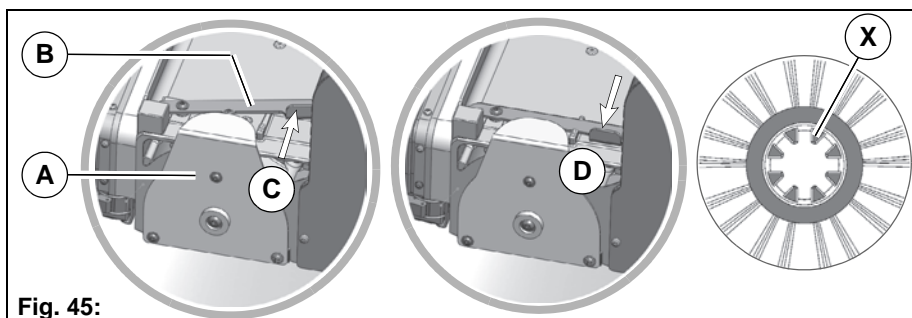

**Fig. 45:**

1. Turn off the machine.
2. Swing down the wiper, see section 5.10.1.
3. Unlock the brush holder **Fig. 45-A**:  
Press the locking lever **Fig. 45-B** into position **C** and remove the brush holder.
4. Pull out the brush.

### 5.7.5 Installing the brushes

1. Push the brush into the housing (teeth **X** must point to the outside) and let the catch on the opposite side engage audibly.
2. Press the locking lever **Fig. 45-B** into position **C** and install the brush holder.
3. Lock the brush holder:  
Push the locking lever into position **D**.
4. Close the wiper, see section 5.10.1



## 5.8 Side brush unit (optional)

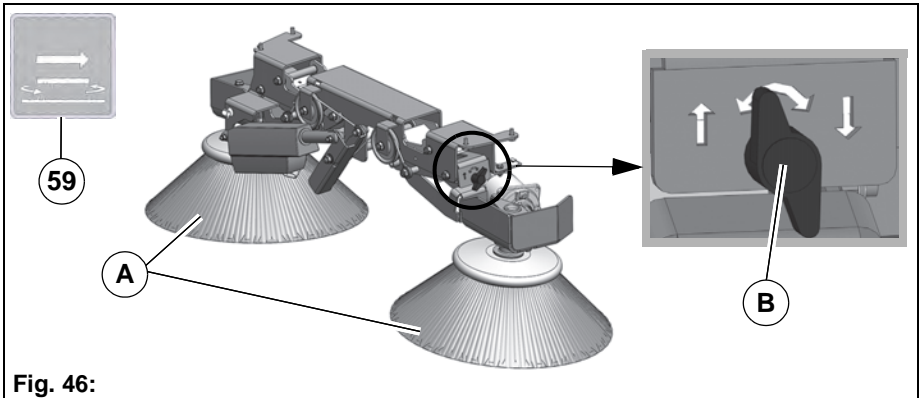

Fig. 46:

### 5.8.1 Adjusting the side brush

#### Side brush tilt

The tilt of the side brush **Fig. 46-A** is preset in the factory and cannot be changed.

#### Readjusting the side brush position

Check side brush weekly for wear. In the event of wear or after changing the side brush, adjust as follows:

1. Place the machine on a level surface.
2. Lower the side brush unit with key *Side brush unit Fig. 46-59*.
3. Turn wing nuts **Fig. 46-B** clockwise at both sides until 1/3 of the area of the side brush is touching the floor.

## 5.8.2 Changing the side brush

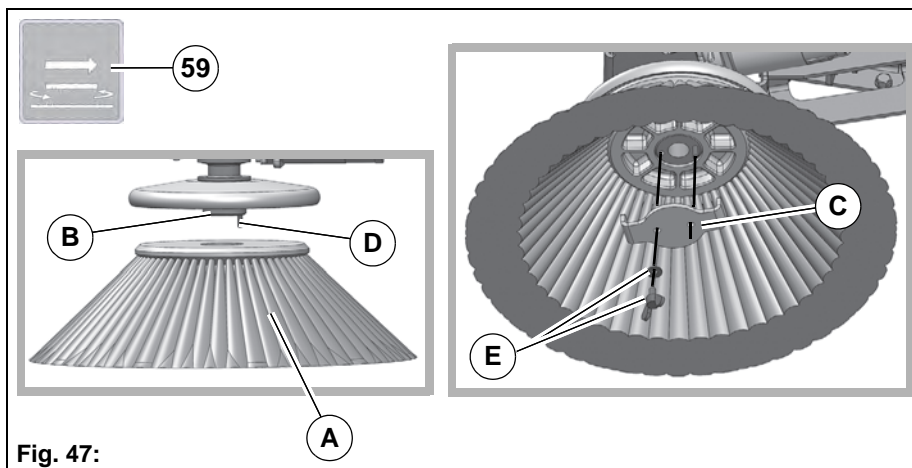

Fig. 47:

### Assembling the side brush

1. Place the machine on a level surface.
  2. Raise the side brush unit with key *Side brush unit* **Fig. 46-59**.
  3. Fit the side brush **Fig. 47-A** to the hub **Fig. 47-B**.
  4. Position the carrier plate **Fig. 47-C** in such a way that the pin of the hub **Fig. 47-D** goes through the hole of the carrier plate and the carrier plate is sitting firmly in the holder.
  5. Secure carrier plate to hub with washer and wing bolt **Fig. 47-E**.
- The side brush is dismantled in the reverse order.

## 5.9 Squeegee

Optimum vacuuming is achieved through:

- clean and undamaged or not worn sealing strips
- correctly set inclination angle and correct height adjustment of the sealing strips.

### 5.9.1 Cleaning the squeegee

Check the squeegee **Fig. 48-29** daily for soiling and foreign particles and clean it as required.

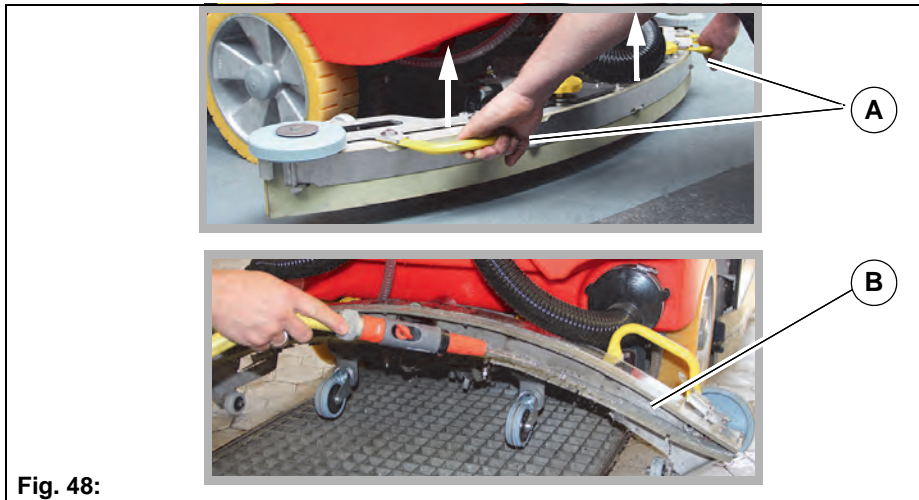

**Fig. 48:**

#### Daily cleaning in the event of heavy soiling:

1. Drive machine to a suitable location with drain in floor:
2. Switch off machine and ensure that the squeegee is in the raised position.
3. Pull off the suction hose **Fig. 49-D**.
4. Fold over the squeegee:
 

Get hold of handles **Fig. 48-A** with both hands. Pull squeegee vertically upwards with a jerk until the flap mechanism activates. Then fold over by 90° as far as possible **Fig. 48-B**.
5. Remove coarse dirt and thoroughly clean the squeegee with the hose.
6. Move squeegee to starting position:
 

Move handles against the direction of travel until the flap mechanism is activated. Then fold over squeegee to starting position.

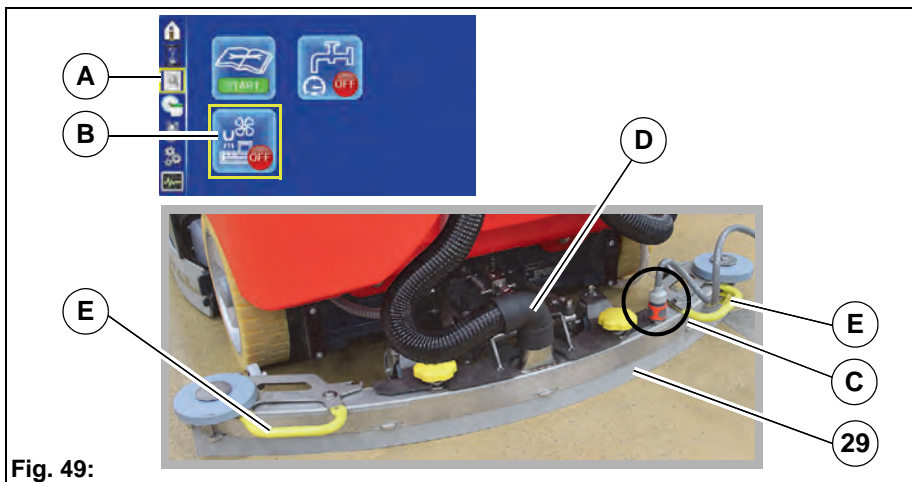

Fig. 49:

#### Daily cleaning in the event of light soiling:

1. Sit on the seat of the machine and switch on the machine.
2. In the sub-menu, call up menu item *Maintenance page Fig. 49-A*. Select soft key *Squeegee cleaning Fig. 49-B* with the turn-push knob and activate. The squeegee is lowered and the suction is switched on.
3. Move the machine forward a little so that the sealing lips are tilted back.
4. Connect hose with 1/2" quick coupling to connection of squeegee **Fig. 49-C** and to water tap.
5. Open water tap fully for approx. 30 seconds.  
Squeegee is cleaned by the internal spray nozzles.

#### After cleaning:

1. Close water tap and remove hose.
2. Sit on driver's seat and select soft key *Squeegee cleaning Fig. 49-B* again and terminate program.

### 5.9.2 Changing the sealing / slot strip

Check the sealing strip **Fig. 50-A** and the slot strip **Fig. 50-B** at the squeegee weekly for wear and damage. If the used sealing edge of the strip is worn or damaged, turn or replace the strip. Each strip can be used four times before it needs replacing.

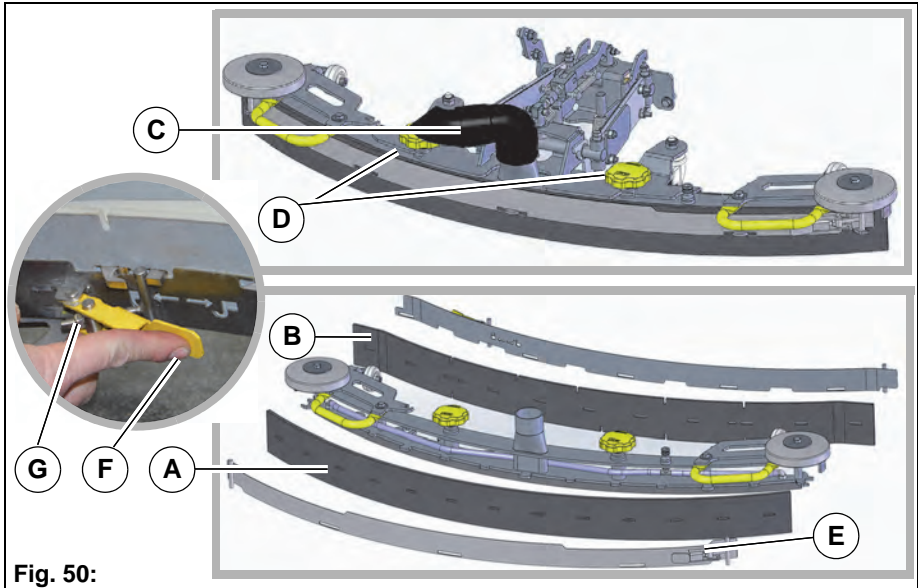

**Fig. 50:**

1. Pull off the suction hose **Fig. 50-C**.
2. Loosen the star-shaped handles **Fig. 50-D** and remove the squeegee.
3. **Replacing the sealing strip:**  
Release the tension strap **Fig. 50-E** and remove.
- Replacing the slot strip:**  
Fold over the turnbuckle **Fig. 50-F** all the way when releasing so that the tension strap is easier to remove.
4. Remove strip from squeegee body.
5. Before turning or replacing the strips, thoroughly clean the squeegee body!  
Assembly is in reverse order.



#### Note

The strips can be of different thickness. The turnbuckles must be readjusted if necessary **Fig. 50-G**.

### 5.9.3 Adjusting the sealing strips

#### Inclination adjustment

The correct inclination adjustment is decisive for:

- ensuring that the sealing strips of the squeegee rest evenly with the complete contact surface on the ground,
- ensuring that the squeegee runs smoothly and evenly during the suction process.

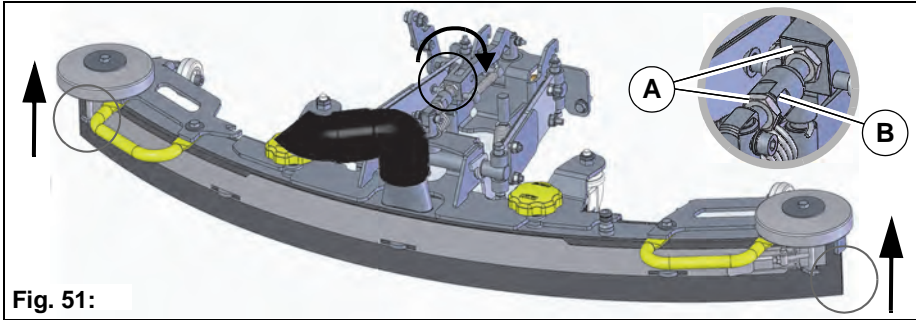

Fig. 51:

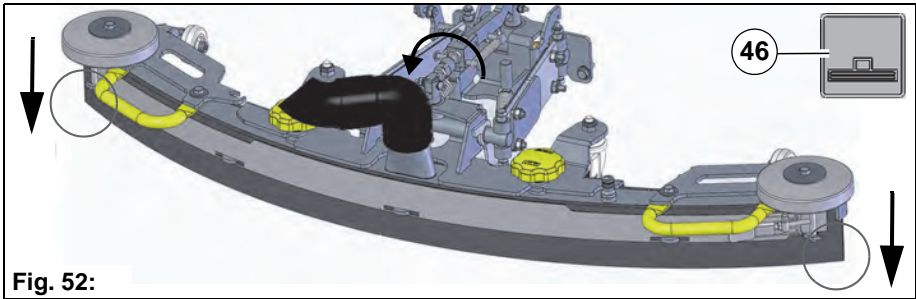

Fig. 52:

1. Place the machine on a level surface and lower the squeegee with the squeegee key **Fig. 52-46**.
2. Loosen the lock nuts **Fig. 51-A** and turn the adjusting bushing **Fig. 51-B** to adjust the squeegee so that the ends of the sealing strips barely have contact with the ground.

#### Turning the adjusting bushing clockwise:

The distance of the sealing strip to the ground increases at the ends **Fig. 51**.

#### Turning the adjusting bushing counter-clockwise:

The distance of the sealing strip to the ground decreases at the ends **Fig. 52**.

3. Turn on the machine and check the suction pattern. When driving, the sealing strips must be turned over evenly everywhere (centre and outside).

4. Tighten the lock nuts:

### Height adjustment

The height adjustment (X) of the supporting rollers **Fig. 53-A** has been set to 7 mm in the factory. If striping still occurs despite optimum inclination adjustment, readjust the distance between the supporting rollers and the lower edge of the sealing strip.

Distance from floor (X)	Use
<7 mm	Very smooth floor surfaces, e.g. coated screed, PVC, linoleum
<b>7 mm</b>	<b>Standard setting</b>
>7 mm	Very uneven floor surfaces, e.g. poorly laid tiles (water does not drain off)

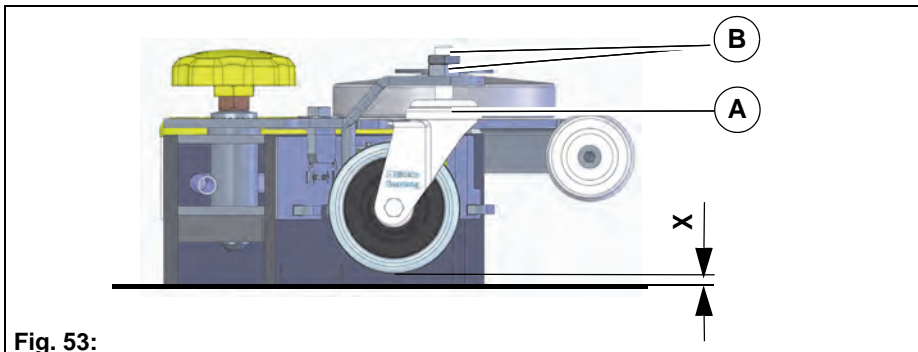

**Fig. 53:**

1. Place the machine on a level surface.
2. Lower the squeegee. The sealing strips must now be resting vertically onto the floor.
3. Loosen nuts **Fig. 53-B** and adjust distance between supporting roller and ground as per the table.
4. Tighten nuts.

## 5.10 Wiper

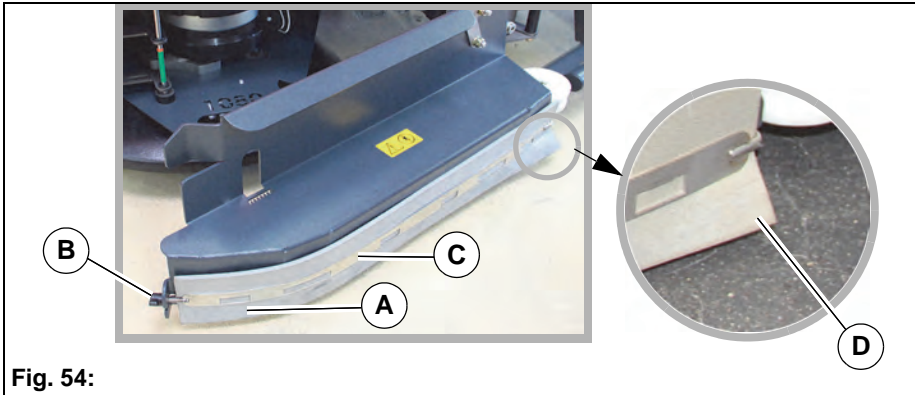

Fig. 54:

### 5.10.1 Changing the wiper rubber

Check the rubber of the wiper **Fig. 54-A** weekly for wear, turn or replace the rubber if necessary.

1. Loosen the wing nut **Fig. 54-B**.
  2. Remove the clamping band **Fig. 54-C**.
  3. Turn the rubber of the wiper (can be used 4 times) or replace it.
- Assembly is in reverse order.



#### Note

During installation, ensure that the corner of the wiper rubber is pointing outwards **Fig. 54-D** so that the wiper rubber folds over outwards during operation.



## 6 Attachments/options

### 6.1 Spray suction tool

The spray suction tool **Fig. 55-A** is used for manually cleaning difficult-to-reach points.



#### Attention

- The spray suction tool is used to suck up dust. Only suck with the addition of water!
- Do not use the spray suction tool while driving!



#### Note

Before starting up for the first time, the provided adapter must be securely attached to the end of the hose **Fig. 55-B**.

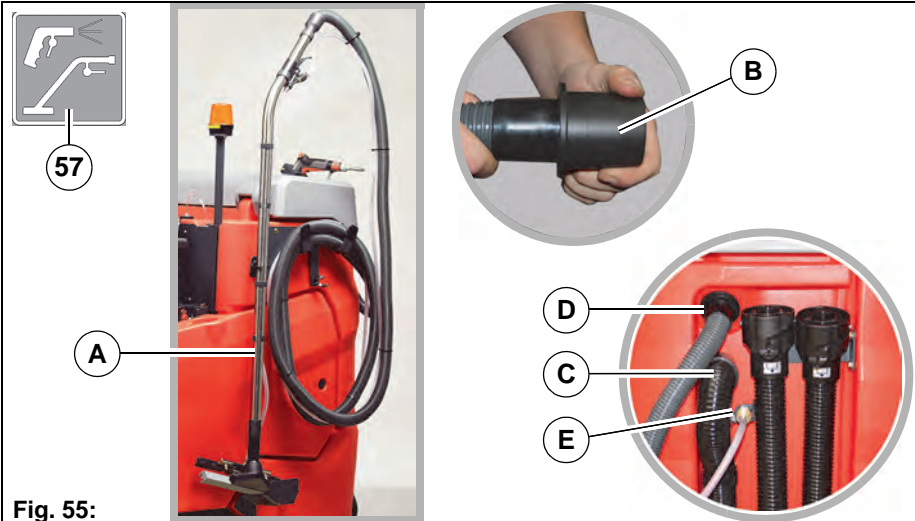

**Fig. 55:**

1. Reconnect the suction hose in the park position **Fig. 55-C**.
2. Insert the hose of the tool into the opening of the vacuum system **Fig. 55-D**.
3. Connect the hose to the water connection of the machine **Fig. 55-E**.
4. Use the *tool operation* button **Fig. 55-57** on the control panel to switch the tool on and off. The operator must not be sitting on the seat.  
Push the button twice: Spray suction tool ON  
Push the button again: Spray suction tool OFF

## 6.2 Manual suction tool:

The manual suction tool **Fig. 56-A** is used for manually cleaning difficult-to-reach points.



### Attention

- The manual suction tool is not used to suck up dust. Only suck up water!
- Do not use the spray suction tool while driving!

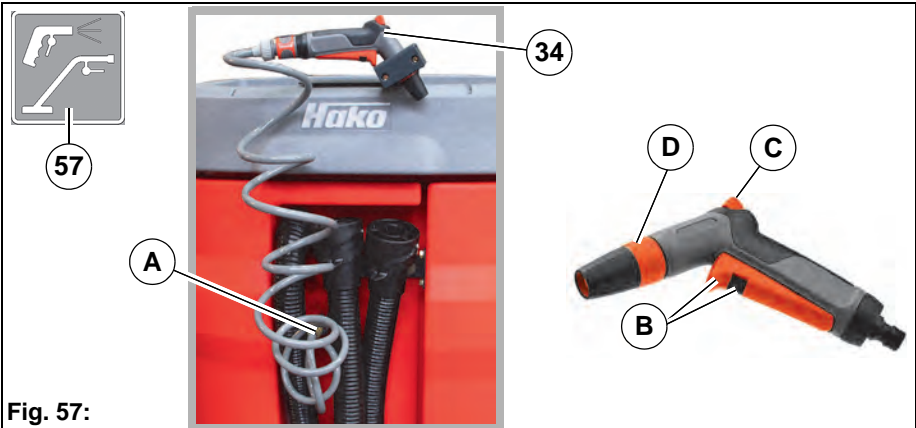

**Fig. 56:**

1. Reconnect the suction hose in the park position **Fig. 56-B**.
2. Insert the hose of the tool into the opening of the vacuum system **Fig. 56-C**.
3. Use the *tool operation* button **Fig. 56-57** on the control panel to switch the tool on and off. The operator must not be sitting on the seat.  
 Push the button twice: Manual suction tool ON  
 Push the button again: Manual suction tool OFF

### 6.3 Spray nozzle

The spray nozzle **Fig. 57-34** is used to flush the solution tank and waste water tank.



**Fig. 57:**

1. Connect the hose to the water connection of the machine **Fig. 57-A**.
2. Use the Tool operation button **Fig. 57-57** on the control panel to turn the water supply on and off. The operator must not be sitting on the seat.  
Push the button: Spray nozzle water supply ON  
Push the button again: Spray nozzle water supply OFF
3. Spray nozzle operation:
  - B** = operating handle for turning the water supply with locking mechanism on and off.
  - C** = adjusting lever for water dosing.
  - D** = setting the type of water jet.



## **EC Declaration of Conformity**

**Hako GmbH**  
**Hamburger Str. 209-239**  
**23843 Bad Oldesloe, Germany**

declare in sole responsibility that the following products

**Scrubmaster B175 R, type: 7180**

on which this declaration is based correspond with the relevant basic safety and health requirements of the EC Directive 2006/42/EC as well as the requirements according to 2014/30/EC.

The following standard(s) and technical specifications was/were referred to for the correct implementation of the safety and health requirements named in the EC Directive:

**EN 60335-2-72**  
**EN 55012**  
**EN 61000-6-2**

Name of the authorised person who compiles the technical documents for Hako:

Ludger Lüttel

Bad Oldesloe, 01.04.2016



Ricardo Ruiz Porath  
Product line manager – cleaning technology



### **Hako: environmentally friendly from the start**

We want to leave a clean earth behind. Protecting resources, environment and the climate therefore governs all our activities. Independent institutes have confirmed this. You will find out more about our commitment on [www.hako.com](http://www.hako.com)

### **Everywhere and quite close to you**

Our efficient distribution and service network guarantees short journeys and fast help.

### **Purchasing, rental, leasing**

We offer you a multitude of individual and attractive financing and procurement possibilities.

### **We are here for you day and night**

The Hako stand-by and spare parts express service guarantees the highest availability.

### **Reliable cleanliness**

Our machines satisfy your highest demands. Reliability thanks to quality "Made by Hako".



Hako GmbH  
Head Office  
Hamburger Str. 209-239  
23843 Bad Oldesloe  
Germany  
Tel. +49(0)4531-806 0  
[info@hako.com](mailto:info@hako.com)  
[www.hako.com](http://www.hako.com)